

## Reference Guide for Microprocessor Controller

Please read and save these instructions for future reference. Read carefully before attempting to assemble, install, operate or maintain the product described. Protect yourself and others by observing all safety information. Failure to comply with these instructions will result in voiding of the product warranty and may result in personal injury and/or property damage.

**DOAS v10.9**  
**Version date 4/26**

**Technical Support**  
 Call: 1-800-789-8550  
 Email: [support@doas.com](mailto:support@doas.com)



### Introduction

#### Program Features

The microprocessor controller offers control through easy monitoring and adjustment of unit parameters by way of a lighted graphical display and an integral push-button keypad.

#### Pre-Programmed Operating Sequences

The controller has been pre-programmed to offer multiple control sequences to provide tempered air. Factory default settings allow for easy setup and commissioning. The sequence parameters are fully adjustable. Refer to the Sequence of Operation for details.

#### BMS Communication

The user can remotely adjust setpoints, view unit status points and alarms. The microprocessor controller is capable of communicating over several protocols:

- BACnet® MSTP
- Modbus RTU
- BACnet® IP
- Modbus TCP

Reference Points List for a complete list of BMS points.

#### Built-In Occupancy Schedule

The controller has an internal programmable time clock, allowing the user to set occupancy schedules for each day of the week. The controller option also has morning warm-up and cool down capability for improved comfort at the time of occupancy.

#### Alarm Management

The microprocessor controller will monitor the unit's status for alarm conditions. Upon detecting an alarm, the controller will record the alarm description, time, date, and input/output status points for user review. Alarms are also communicated via BMS (if equipped).

#### Occupancy Modes

The microprocessor controller offers three modes of determining occupancy: a digital input, occupancy schedule or the BMS. If in the unoccupied mode, the unit will either be shut down, continue normal operation utilizing adjustable unoccupied setpoints, recirculate with unoccupied setpoints or will cycle on to maintain adjustable unoccupied space temperature and humidity setpoints (space temperature and humidity sensor is optional).

#### Remote Unit Access (if equipped)

The WebUI and Remote Display are two ways to gain access to the unit controller allowing monitoring of the unit and parameter adjustment without being at the unit.

The WebUI can be accessed via a building network and is included with every unit controller. The Remote Display is an LCD to be panel mounted in a remote location and is an option available for purchase.

#### ⚠ WARNING

For A2L appliance only. LEAK DETECTION SYSTEM installed. Unit must be powered except for service.

#### ⚠ WARNING

Electrical shock hazard. Can cause personal injury or equipment damage. Service must be performed only by personnel that are knowledgeable in the operation of the equipment being controlled.

#### ⚠ WARNING

Mechanical high static protection cutoffs must be installed by others to protect the system and equipment from over-pressurization when using factory provided control sensors. The manufacturer does not assume responsibility for this.

## Table of Contents

<b>Sequence of Operation</b> . . . . .	3
<b>Display Use</b> . . . . .	10
<b>Parameter Adjustment</b> . . . . .	10
<b>Web User Interface</b> . . . . .	11
<b>Main Menu</b> . . . . .	12
<b>Unit Status Overview</b> . . . . .	13
<b>Menu</b>	
Unit Enable . . . . .	18
Control Variables	
Temp Control . . . . .	18
Dehumidification . . . . .	21
Refrigeration . . . . .	22
Economizer Mode . . . . .	23
Damper Control . . . . .	24
Energy Recovery . . . . .	25
Supply Fan Control . . . . .	25
Exhaust Fan Control . . . . .	26
Occupancy . . . . .	27
Advanced . . . . .	28
Alarms . . . . .	35
<b>Appendix</b>	
<b>A:</b> Remote Display . . . . .	36
<b>B:</b> I/O Expansion Board Quick Start . . . . .	37
<b>C:</b> Space Thermostat Quick Start . . . . .	38
<b>D:</b> GreenTrol® Airflow Monitoring Quick Start . . . . .	40
<b>E:</b> Points List . . . . .	41
<b>F:</b> Modbus Connections . . . . .	53
<b>G:</b> NTC Temperature Sensor Chart . . . . .	53
<b>H:</b> Fault Detection and Diagnostics . . . . .	54
<b>I:</b> Refrigerant Leak Detection Systems . . . . .	55
<b>Our Commitment</b> . . . . .	Backcover

The microprocessor controller can be configured for air handler, energy recovery, and dedicated outdoor air systems. Each application utilizes similar technologies for heating and cooling: chilled water, hot water, indirect gas, electric heat, and packaged removed DX cooling. All setpoints, lockouts and delays are user adjustable via the integral keypad display, remote display, or web user interface.

### General Operation

#### UNIT DISABLED COMMAND:

The unit becomes disabled due to the following:

- The unit was disabled from the controller's Unit Enable screen.
- The unit was disabled from the BMS.
- The remote start input is in the off position.
- The shutdown input is in the shutdown position.
- A system shutdown alarm was activated
- Fire safety shutdown alarm was activated

**UNIT START COMMAND:** The microprocessor controller requires a digital input to enable operation. The unit can then be commanded on or off by this digital input, keypad, the BMS or schedule. When a start command becomes active the following steps occur:

- Factory mounted and wired dampers are powered (Outside air, exhaust air, and recirculation air dampers, if equipped)
- Exhaust fan, if equipped, starts after adjustable delay
- Energy recovery wheel starts, if equipped
- Supply fan starts after adjustable delay
- Tempering operation starts after adjustable delay

**UNIT STOP COMMAND:** A shutdown occurs when there is not an occupied or unoccupied start command. The following shutdown methods can occur.

Hard shutdown occurs under the following conditions:

- A user or the BMS disables the system, and the supply temperature is less than the soft shutdown enable setpoint.
- Occupancy is commanded to unoccupied while there is no unoccupied start command, and the supply temperature is less than the soft shutdown enable setpoint.

When a hard shutdown occurs:

- The unit shuts down immediately.
- Dampers spring-return to their off position. Damper power is cut 30 sec. after the fans. This allows the fans to slow down prior to spring closing the dampers.

Soft shutdown occurs under the following conditions:

- A user or the BMS disables the system, and the supply temperature is greater than or equal to the soft shutdown enable setpoint.
- There is no unoccupied or occupied start command and the supply temperature is greater than or equal to the soft shutdown enable setpoint.

The following occurs during a soft shutdown:

- Tempering outputs immediately revert back to their off value; while
- Dampers remain open and fans continue to run; until
  - The supply air temperature falls below the soft shutdown enable setpoint minus 5.0°F; or
  - The soft shutdown delay timer has expired.

**OCCUPANCY:** The microprocessor controller offers five modes of determining occupancy: digital input, occupancy schedule, BMS, always occupied, or always unoccupied. When in the unoccupied mode, the unit can be configured to shut down, or cycle on to maintain the unoccupied space setpoints. The unit can be temporarily overridden to the occupied mode via a digital input, keypad display, or space thermostat, if equipped.

#### • Occupied Mode:

- Damper Control (refer to Outside Air and Recirculated Air section), if equipped
- Exhaust fan on, if equipped
- Energy Recovery Control (refer to Energy Recovery section), if equipped
- Supply fan on
- Tempering Operations begin

#### • Unoccupied Mode:

- **Unit Off:** Unit remains off when in unoccupied mode.
- **Normal operation with unoccupied setpoints:** Unoccupied mode will operate as if in occupied mode but will utilize adjustable unoccupied setpoints.
  - Damper Control (refer to Outside Air and Recirculated Air section), if equipped
  - Exhaust fan on, if equipped
  - Energy Recovery Control (refer to Energy Recovery section), if equipped
  - Supply fan on
  - Tempering Operations begin
- **Recirculation with unoccupied setpoints:** Unoccupied mode will operate using adjustable unoccupied set points when a recirculation damper is available.
  - Supply fan on
  - Recirculation air damper open
  - OA damper opens to unoccupied minimum position (0% adj.)
  - Tempering operations begin
  - Exhaust fan off, if equipped
  - Energy recovery control off, if equipped
- **Night Setback:** Unoccupied mode when there is space temperature and/or humidity sensor(s) connected to the controller. The unit will cycle on to maintain unoccupied space setpoints if there is a call for unoccupied heating, cooling or dehumidification.

## Sequence of Operation

- » Recirculation air damper open
- » OA damper opens to unoccupied minimum position (0% adj.)
- » Supply fan on
- » Tempering operations begin
- » Exhaust fan off, if equipped
- » Energy Recovery off, if equipped

• **Morning Warm-Up/Cool Down:** When enabled, the unit will operate in a morning warm-up or cool-down sequence at the start of the scheduled occupancy time. Heating or cooling must be available (not locked out), and the space temperature must be outside the setpoint by the unoccupied hysteresis (adj, default 5°F). The unit will run in this sequence for up to 30 min (adj), or until the occupied setpoint is reached, whichever occurs first. This optional feature requires a space temperature sensor and must be enabled in the field.

The following steps occur during a morning warm-up/cool down:

- The dampers would be in full recirc if the damper actuators are not powered (adj) during unoccupied mode. Otherwise the following is true:
  - » Outside air damper is open to unoccupied minimum OAD position.
  - » Recirculation air damper is open at 100% minus OAD position.
- Supply Fan is on at 100%.
- Exhaust fan is off
- In heating, controls to maintain the maximum supply setpoint (90°F).
- In cooling, controls to the minimum supply setpoint (50°F).
- Reheat off
- Energy recovery wheel off

### Setpoint Control (Continuous)

When the unit is running continuously, the supply air temperature setpoint can be configured as a constant value or reset by either outside air temperature, space temperature, or return temperature. Supply air temperature reset modes can be set for both occupied and unoccupied operation in the controller. If equipped with BMS communications, the BMS system can also directly command the temperature setpoint.

- **Outside Air Temperature Reset:** The controller will adjust the supply air temperature setpoint based on the OA temperature between the min (55°F) and max (70°F). The min and max setpoints can be locally adjusted at the microprocessor for the outside temperatures and the supply air temperature min and max.
- **Space Temperature Reset:** The controller will adjust the supply air temperature setpoint between the min (55°F) and max (90°F) to satisfy the desired

occupied or unoccupied space temperature setpoints with a valid space temperature reading. The space temperature setpoint for occupied and unoccupied mode can be adjusted locally at the microprocessor or the BMS. Occupied temperature setpoints can be adjusted at the space thermostat.

- **Return Temperature Reset:** The controller will adjust the supply air temperature setpoint between the min (55°F) and max (90°F) to satisfy the desired occupied or unoccupied return temperature setpoint with a valid return temperature reading. The return temperature setpoint can be adjusted locally at the microprocessor or the BMS.

---

### Setpoint Control (Night Setback)

When the unit is set to cycle on space temperature in night setback, the supply air temperature is automatically set using the following strategy:

- **Heating:** The unit is enabled when the space temperature is less than the unoccupied heating setpoint (60°F). The unit cycles off when the space temperature increases above the unoccupied heating setpoint by the hysteresis amount (5°F). During this time, the supply air temperature setpoint is set to the supply max reset limit (90°F).
- **Cooling:** The unit is enabled when the space temperature is greater than the unoccupied cooling setpoint (80°F). The unit cycles off when the space temperature decreases below the unoccupied cooling setpoint by the hysteresis amount (5°F). During this time, the supply air temperature setpoint is set to the supply min reset limit (55°F).
- **Dehumidifying:** The unit is enabled when the space relative humidity exceeds the unoccupied space relative humidity setpoint (60%). The unit cycles off when the space humidity decreases by the unoccupied dehumidification hysteresis amount (5%). The supply air temperature setpoint will be set to the equivalent occupied supply setpoint. This sequence requires a valid space humidity reading and is field enabled. Alternatively, the unoccupied dehumidification control can be triggered by space dewpoint, space dewpoint or relative humidity or space dewpoint and relative humidity.

---

### Heating

The heating is controlled to maintain the supply temperature setpoint. The heating will be locked out when the outside air temperature is above the heating lockout (80°F adj).

- **Indirect Gas Furnace:** Microprocessor controller will modulate the indirect gas furnace to maintain the supply temperature setpoint.

## Sequence of Operation

- **Hot Water:** Microprocessor controller will modulate a hot water valve (provided by others) to maintain the supply temperature setpoint. **Coil freeze protection must be provided by others in the field!**
- **Electric Heater:** Microprocessor controller will modulate an electric heater to maintain the supply temperature setpoint.

---

### Cooling

The cooling is controlled to maintain the supply temperature setpoint. The cooling will be locked out when the outside air temperature is below the cooling lockout (55°F).

- **Chilled Water:** Microprocessor controller will modulate a chilled water valve (provided by others) to maintain supply air setpoint. **Coil freeze protection must be provided by others in the field!**
- **Mechanical Cooling:** The microprocessor controller enables stages of cooling to maintain the supply air setpoint. A single modulating compressor or a modulating compressor with additional fixed-stage compressors will stage on and off based on the current supply temperature and desired setpoint. Compressors will be disabled if the cooling coil temperature remains below the Cooling Coil Low Limit for three minutes.

---

### Active Head Pressure Control

Mechanical cooling systems with integrated condenser sections will maintain head pressure control by utilizing transducers on each refrigerant circuit. The pressure reading from the transducer is converted to a saturated discharge temperature for each circuit. The temperature, or maximum temperature when two circuits are present, is compared to a setpoint.

The following sequences are based on the type of condenser fan modulation installed in the unit.

- **Lead Modulating Fan:** A unit with this option has one modulating condenser fan per fan bank. The modulating condenser fan utilizes an analog output to vary the speed of the fan. The modulating fan turns on with the start of the first compressor. When the saturated temperature is above setpoint, the modulating fan speed will increase to maintain head pressure. When below setpoint, the fan speed will decrease.

Additionally, non-modulating fans are staged using digital outputs and an offset. Each additional stage turns on based on the saturated temperature reaching setpoint plus an offset and turns off when the temperature falls below setpoint. Built-in delays between stages assist in staging fans off or on too quickly.

- **All Modulating Fans:** A unit with this option has all modulating condenser fans. One analog signal modulates all fans in a bank. The first fan stages on with the start of the first compressor. The fans modulate to maintain the saturated discharge temperature setpoint. When the saturated temperature is above setpoint, the fan speed will increase to maintain head pressure. When below setpoint, the fan speed will decrease.

---

### Sliding Head Pressure Control

The head pressure control setpoint changes based on the outside air temperature and an offset. As the outside temperature increases so does the control setpoint for the condenser fans. This feature is active in cooling and dehumidification modes unless disabled in the controller. Sliding head pressure control is enabled by default.

---

### Air Source Heat Pump

When a unit is configured as an ASHP, compressors are used for cooling and heat pump heating. A reversing valve is energized when the unit is in heating mode to reverse the flow of the refrigerant. The ASHP is only available as a packaged unit with an inverter scroll as the lead compressor.

- **Cooling:** Mechanical cooling operates the same as any other unit with compressors by controlling the compressors to maintain the supply air temperature setpoint in cooling mode and to maintain the cooling coil temperature in dehumidification mode.
- **Heat Pump Heating:** When heat is required, the reversing valve is switched, and the compressors are staged to maintain the supply air temperature setpoint.
- **Heat Pump Heating Lockout:** Heat pump heating may be locked out for any of the following reasons:
  - Defrost is initiated 3 times in one hour.
  - Supply Air temperature is 5°F (adj.) below setpoint for more than 10 minutes (adj.), there is not a morning warm-up sequence call from the controller, and secondary heat is available as backup only.
  - Outside ambient temperature is below the HP ambient lockout setpoint (0°F).
- **Resetting HP Heating Lockout:** One of the following conditions must occur to return to HP heating:
  - The outside temperature increases by 5°F.
  - The outside humidity decreases by 20%RH, if humidity sensor is installed.

## Sequence of Operation

- The unit has been locked out for more than 2 hours when a humidity sensor is not installed and not locked out on low ambient condition
- If the HP heating is locked out due to the supply air temperature being lower than the setpoint, HP heating will be allowed to retry after 120 minutes of backup heating.

• **Defrost:** Periodically, the ASHP need to initiate a defrost cycle to remove accumulated frost from the outside coil when operating in heating mode. The saturated suction temperature, the outside ambient temperature and/or the outside humidity determine when a defrost initiates and terminates.

**Initiation:** One of the following must be true for a defrost cycle to initiate:

- The saturated suction temperature is less than -15°F; or
- The saturated suction temperature is less than ambient conditions (temp/dewpoint) minus an offset (35°F/25°F).

**Termination:** The defrost cycle is terminated when one of the following occur:

- The saturated discharge temperatures of all refrigerant circuits are greater than the cancel defrost setpoint (80°F); or
- The max defrost time (5 min) has been exceeded.

**Damper Control:** During heat pump defrost, the control of dampers will be determined based on the configuration of the unit.

- **100 % Outside Air:** When a recirculating damper is NOT available, the outside air damper will remain 100% open.
- **Recirculating Air:** When a recirculating damper is installed in the unit, by default, the outside air damper will close, and the recirculating air damper will open to 100%. This option is adjustable by changing the HP Defrost Damper Position to “Control OAD” from “Full Recirc” in the Advanced Setpoints menu.
  - » When “Full Recirc” is selected the following will also occur if the unit is equipped:
    - \* Exhaust Fan will turn off.
    - \* Energy Recovery device will stop or close.

• **Outside Coil Fan Control:** Head pressure control of the outside fans will maintain head pressure control by utilizing transducers on each refrigerant circuit. The outside fan options available on the ASHP are lead modulating or all modulating fans and utilize refrigerant transducers to stage fans on and off in cooling/dehumidification and heating modes.

- **Cooling/Dehumidification:** Reference the Active Head Pressure Control section of the IOM for operation in cooling and dehumidification modes

of operation.

- **Heating:** In heating mode, the pressure reading from the transducer is converted to a saturated suction temperature for each circuit. The temperature, or minimum temperature when two circuits are present, is compared to a setpoint. When the saturated temperature is below setpoint, the modulating fan speed will increase to maintain head pressure. When above setpoint, the modulating fan speed will decrease. Non-modulating fans, if installed, will stage on and off based on setpoint minus/plus setpoint. This function is similar to the cooling/dehumidification active head pressure control for lead modulating fans.

- **Defrost:** When defrost is initiated, the outside fans turn off allowing the heat to build and defrost the outside coil. When defrost is terminated, the outside fans turn on to bring the pressure down before switching back to heating mode

• **Secondary Heat:** A secondary heating device may be installed in the unit. This device may be electric heat, gas furnace, or a hot water coil. The following sequences are available for secondary heat:

- **Backup:** Secondary heat only operates when heat pump heating is not available.
- **Supplemental:** Secondary heat will operate simultaneously with heat pump heating when the compressors are not producing enough heat to stay within 2°F of setpoint.

---

## Economizer

If the application requires cooling, and the OA conditions are suitable for free cooling, the controller will enter economizer mode. If the unit is economizing and the discharge temperature setpoint is not being met, the controller will bring on mechanical cooling. If equipped with a modulating OA and recirculated air damper, the dampers will modulate between the min OA and max positions to maintain the supply temperature setpoint. If equipped with energy recovery, reference the Energy Recovery sequence.

- **Temperature:** The economizer will be locked out when:
  - The outside air is less than the economizer minimum lockout (40°F) and greater than the economizer maximum lockout (65°F).
  - There is a call for heating.
- **Temperature/Enthalpy:** The economizer will be locked out when:
  - The outside air is less than the economizer minimum lockout (40°F) and greater than the economizer maximum lockout (65°F).
  - The outside air is greater than the economizer high enthalpy lockout (23 btu/lb).
  - There is a call for heating.

### Dehumidification

Dehumidification enable can be selected based on any of the following sensor readings: outside air temperature, indoor dew point, indoor relative humidity, or outside dew point.

- **Outside Temperature:** Dehumidification is enabled when the OA temperature is greater than the cold coil setpoint plus an offset (10°F). Dehumidification is disabled when the OA temperature falls below the enable point by a hysteresis (2°F).

The following enable setpoints may be used separately or in conjunction with one another. Each has a setpoint to enable dehumidification and uses a temperature or humidity hysteresis to disable dehumidification.

- **Indoor Dew Point**
- **Indoor RH**
- **Outside Dew Point**

A constant call for dehumidification must be present for the duration of the enable delay for the dehumidification mode to become enabled. The call remains active until conditions are satisfied and dehumidification mode has been active for the minimum active time.

- **Cooling Coil Setpoint:** When an indoor humidity sensor or temperature and humidity sensors (space or return) are installed, the controller can adjust the cold coil leaving air temperature setpoint between the minimum (50°F) and maximum (55°F) setpoint. This function can be enabled or disabled by selecting the reset mode for the setpoint.

### Reheat

While the unit is dehumidifying, the supply air temperature is maintained by controlling the reheat device to the supply air setpoint.

- **Hot Gas Reheat (valve):** The microprocessor controller modulates to maintain setpoint. A hot gas reheat purge cycle is activated based on valve position and elapsed time when a compressor is running in the hot gas reheat circuit. This purge is also used for oil management when the compressor operates within a specific speed range. During the purge cycle the hot gas reheat valve and compressor speed is adjusted to allow proper oil and refrigerant return.
- **Reheat Plus:** The microprocessor controller can be configured to use the primary heat source as secondary reheat.

### Supply Fan VFD Sequence

The factory installed VFD is wired to the controller.

Supply fan speed needs to be set during test and balance of the unit. If equipped with BMS communications, the user can also directly command the supply fan speed. The following sequences are selectable for supply fan control. The fan speed is constrained by its min and max speed setpoints.

- **Constant Volume:** Supply fan operates at a constant speed based on a constant volume setpoint based on occupancy.
- **0-10 VDC:** The supply fan is enabled by the unit controller. An external field-supplied 0-10 VDC signal is responsible for modulating the supply fan's speed.
- **CO<sub>2</sub> Control:** The supply fan modulates to maintain CO<sub>2</sub> setpoint based on a sensor located in the space or return duct. A CO<sub>2</sub> sensor or BMS communicated value is required for this sequence.
- **Duct Static Pressure:** The supply fan modulates to maintain an adjustable duct static setpoint based on a sensor located in the supply duct. A static pressure sensor or BMS communicated value is required for this sequence.
- **Space Static Pressure:** The supply fan modulates to maintain a space static pressure setpoint based on a sensor located in the space. A space static pressure sensor or BMS communicated value is required for this sequence.
- **Single Zone VAV:** The controller will control the supply air temperature and supply fan speed in order to maintain the space temperature.
  - **Heating Mode** - The supply temperature setpoint will be increased before increasing the supply fan speed in order to maintain the space temperature setpoint. If the calculated supply temperature setpoint is greater than the current space temperature, the supply fan speed will be increased while the supply temperature setpoint is increased.
  - **Cooling Mode** - The supply temperature setpoint will be decreased before increasing the supply fan speed in order to maintain the space temperature setpoint.
- **Two Speed:** The supply fan is enabled by the unit controller. An external field-supplied digital contact is responsible for enabling high speed operation.

The supply fan min (50%) and max (100%) speeds are used for the low and high speed settings.

### Exhaust Fan VFD Sequence

The factory installed VFD is wired to the controller. Exhaust fan speed needs to be set during test and balance of the unit. If equipped with BMS communications, the user can also directly command the exhaust fan speed. The following sequences are

## Sequence of Operation

selectable for exhaust fan control. The fan speed is constrained by its min and max speed setpoints.

- **Constant Volume:** Exhaust fan operates at a constant speed based on a constant volume setpoint based on occupancy.
- **0-10 VDC by Others:** The exhaust fan is enabled by the unit controller. An external field-supplied 0-10 VDC signal is responsible for modulating the exhaust fan's speed.
- **Space Static Pressure:** The exhaust fan modulates to maintain a space static pressure setpoint based on a sensor located in the space. A space static pressure sensor or BMS communicated value is required for this sequence.
- **Supply Fan Tracking:** The exhaust fan proportionally modulates based on the supply fan speed plus an adjustable offset (-10%).
- **Outside Air Damper Tracking:** The exhaust fan proportionally modulates based on the outdoor air damper modulation. (This sequence requires a modulating outdoor air damper.
- **Exhaust Fan Only Mode:** This fan mode is an optional fan mode available where the exhaust fan and the modulating outside air damper, if equipped, are the only devices enabled. A contact closure enables the mode and forces the exhaust fan to run at 100%. The OA damper is forced to the OAD Exhaust Fan Only position (100%) during this operation. All other fans and tempering devices are disabled during this mode of operation.

---

### Outside Air and Recirculated (Recirc) Air Damper Control

If equipped with a modulating OA and recirculated air damper, the recirculated air damper will operate inverse of the OA damper. The OA damper opens to its min position. If the controller is configured to modulate the supply fan speed, the min and max OA positions can be reset based on supply fan speed. If equipped with BMS communications, the BMS can directly control the outside damper position. The damper position is constrained by its min and max setpoint positions.

- **CO<sub>2</sub> Control:** The controller will proportionally modulate the OA/RA dampers based upon a comparison of the CO<sub>2</sub> setpoint to the actual CO<sub>2</sub> level reported from the sensor. As the CO<sub>2</sub> level rises, the controller will proportionally modulate the OA damper open, between the min OA damper position and max CO<sub>2</sub> position.
- **Space Static Pressure:** The OA/RA dampers will modulate based upon the signal from a building static pressure sensor. The controller will modulate the dampers, between the min and max OA positions, based upon a comparison of the building

static pressure setpoint to the actual building static pressure level reported from the sensor.

- **0-10 by Others:** An external field supplied 0-10 VDC signal is responsible for setting the damper position.
- **Two Position:** An external field supplied digital contact is responsible for setting the damper to max position. The OA Damper min (30%) and max (100%) positions are used for the low and high position settings.

---

### Refrigerant Leak Mitigation

Refrigerant leak sensors are installed in the airstream section if the unit has a compressor. An additional sensor is installed in the compressor section if the unit has indirect gas furnace heating. The refrigerant leak alarms are ignored if a fire shutdown alarm is active.

- **Refrigerant leak detected in airstream section:** Compressors are disabled, unit is set to occupied mode, and the damper actuator position and supply fan speed are adjusted. When the alarm clears, the unit returns to normal operation.
- **Refrigerant leak detected in compressor section:** Compressors and indirect gas furnace are disabled. The unit is allowed to run when the alarm is active based on a variable specified by the user. When the alarm clears, the unit returns to normal operation.
- **Fire safety shutdown alarm is triggered:** Unit is disabled, and refrigerant leak alarms are ignored. When the alarm clears, the unit returns to normal operation.

Reference Appendix: Refrigerant Leak Detection System for additional information.

---

### Energy Wheel Control

**Economizer:** If the unit is equipped with an energy recovery wheel, the economizer will modulate/stop the energy wheel to achieve free cooling.

- **Stop Wheel:** When economizer mode is enabled and there is a call for cooling, the wheel will stop rotating to allow free cooling.
- **Modulate Wheel:** When economizer mode is enabled and there is a call for cooling, the controller modulates wheel speed to maintain the supply temperature setpoint.
- **Energy Wheel Bypass Dampers, if equipped:** During normal operation, the dampers shall remain closed to allow full operation of the energy wheel. During economizer sequences, the dampers will be open to bypass the energy wheel.
- **Jog Wheel Control:** A jog wheel control sequence allows the wheel to rotate for a short period of time exposing a new section to the air stream. This sequence occurs when the wheel has been off for the

## Sequence of Operation

Wheel Jog Delay (60 minutes) and rotates for the Wheel Jog Duration (2 minutes).

**Frost Control (Polymer):** The microprocessor controller will activate the frost control method when the OA temperature is less than the defrost setpoint (5°F) and the wheel pressure switch is closed due to a high wheel pressure drop. Once the pressure drop decreases below the pressure switch point or the OA temperature increases, the unit will resume normal operation.

- **Electric Preheater:** When frosting is occurring, the preheater is energized to defrost the wheel.
- **Modulate Wheel:** When frosting is occurring, the wheel slows to allow defrosting to occur.
- **Cycle Wheel:** When frosting is occurring, the energy wheel is cycled off for a defrost cycle time (5 minutes). After the defrost cycle time, the wheel is re-energized to continue normal operation. The controller will not allow another defrost cycle for a min normal operating cycle time (30 minutes).
- **Timed Exhaust:** When frosting is occurring, the supply fan is cycled off along with the tempering for a defrost cycle time (5 minutes). The exhaust fan will continue to run allowing the warm exhaust air to defrost the wheel. After the defrost cycle time, the supply fan and tempering are re-energized to continue normal operation. The controller will not allow another defrost cycle for a min normal operating cycle time (30 minutes).

**Frost Control (Aluminum):** The microprocessor controller will activate the frost control based on the following methods.

- **Electric Preheater:** When the outdoor air temperature is less than 10°F (adj.), the preheater is energized to defrost the wheel.
- **Modulate Wheel:** When the exhaust air temperature is less than 25°F (adj.), the wheel is modulated to maintain a 25°F exhaust air temperature.

---

### Enthalpic Core Control

**Economizer:** If the unit is equipped with an energy recovery enthalpy core heat exchanger, the economizer will modulate the bypass damper open to achieve free cooling.

- **Modulate Damper:** When economizer mode is enabled and there is a call for cooling, the controller modulates the core bypass damper open to maintain the supply temperature setpoint.

**Frost Control (Enthalpic Core):** The microprocessor controller will activate the frost control based on the following methods.

- **Electric Preheater:** When the outdoor air temperature is less than 10°F (adj.), the preheater is energized to defrost the wheel.

- **Modulate Bypass Damper:** When the exhaust air temperature is less than 30°F (adj.), the bypass damper is modulated to maintain a 30°F exhaust air temperature.

---







### Alarms

The microprocessor controller monitors alarms and will alarm on the following conditions:

- **Dirty Filter Alarm:** If the outside air or return air filter differential pressure rises above the differential pressure switch setpoint, the microprocessor controller will activate an alarm.
- **Supply and Exhaust Air Proving Alarm:** Microprocessor controller monitors fan proving on each blower and displays an alarm in case of blower failure.
- **Sensor Alarm:** Microprocessor controller will send an alarm if a failed sensor is detected (temperature, pressure, relative humidity).
- **Supply Air Low Limit:** If the supply air temperature drops below the supply air low limit (35°F), the controller disables the unit and activate the alarm output after a preset time delay (300 sec.).
- **Condensate Overflow:** Microprocessor controller monitors the float switch installed in the drain pan and will disable the unit and activate an alarm on high condensate.
- **Fire Safety Shutdown Alarm:** If the fire shutdown input is triggered, the controller disables the unit and activates the alarm output.
- **Refrigerant Leak Airstream Alarm:** If a refrigerant leak is detected in the evaporator coil or supply fan sections without an active Fire Safety Shutdown alarm, the controller will: enable the unit, disable compressors, ignore supply air temperature alarms, activate an alarm, and override both supply fan speed and damper actuator signals.
- **Refrigerant Leak Compressor Alarm:** For units with indirect-gas furnace heating, if a refrigerant leak is detected in the compressor section without an active Fire Safety Shutdown alarm, the controller will activate an alarm and disable both furnace and compressors. The unit is allowed to run without tempering based on a variable specified by the user.
- **Other Alarms:** Wheel Rotation, High Wheel Pressure, High Refrigerant Pressure.

## Display Use

The microprocessor controller is located in the unit control center. The face of the controller has six buttons, allowing the user to view unit conditions and alter parameters. The microprocessor controller is pre-programmed with easy to use menus. A remote display is also available.



Keypad Description		
Button	Description	Functions
	Main Menu	Press to go directly to the Main Menu from any screen. From the Main Menu, navigate to the following screens: <ul style="list-style-type: none"> <li>• Unit Enable</li> <li>• Unit Status</li> <li>• Ctrl Variables</li> <li>• Alarm Menu</li> </ul>
	Alarm	The Alarm button flashes when there is an active alarm. Press to view alarms. Press twice to go to the alarms reset screen.
	Escape	Press from the Main Menu to view the Unit Status screen. Press to go back one menu level.
	Up	Press to navigate through the menus/screens. Press after entering a variable to increase a current value.
	Enter	Press to enter a highlighted menu or screen item. Press to enter a writable variable and press again to confirm the new variable value.
	Down	Press to navigate menus/screens. Press after entering a variable to decrease the current value.
<div style="display: flex; justify-content: space-around; width: 100%;"> <div style="border: 1px solid gray; padding: 2px; font-size: 8px;">2 Button Click</div> <div style="border: 1px solid gray; padding: 2px; font-size: 8px;">2 Button Hold</div> </div>		Unit display on web interface only. These two buttons on the virtual keypad/display are used to simulate two-button actions on the handheld keypad/display.  To simulate pressing two buttons simultaneously: <ol style="list-style-type: none"> <li>1. Click on 2-Button Click.</li> <li>2. Then, sequentially click on two keypad buttons (Main, Alarm, Escape, Up, Enter, Down).</li> </ol> To simulate pressing and holding two buttons simultaneously: <ol style="list-style-type: none"> <li>1. Click on 2-Button Hold.</li> <li>2. Then, sequentially click on two keypad buttons (Main, Alarm, Escape, Up, Enter, Down).</li> </ol>

## Parameter Adjustment



The cursor always begins in the upper left corner of the display and will be blinking. Press the  button to move the cursor down for parameter adjustment.



Once the cursor has reached the desired parameter, press the   buttons to adjust the value.



When satisfied with the adjustment, press the  button to save the parameter. When finished, make certain the cursor is in the upper left corner. If the cursor is not in the upper left corner, the changes will not be saved. The cursor must be in the upper left corner to enable screen advancement.

## Web User Interface

The Web User Interface allows access to the unit controller through the building network. Reference Ctrl Variables/Advanced/Network Settings to set the IP network protocol. Once proper communication is established, the user can click on the follow tabs:

**Overview** – Includes a functioning unit graphic, monitoring points, and active setpoint adjustment.

**Alarms** – Shows current and cleared alarms.

**Trending** – User can view past and present controller points.

**Information** – Provides manufacturer support information as well as IOM resources.

**Service** – User must be logged in with service access criteria (9998). Once proper login is established, the user can view configured input/output points associated with the unit controller

### Pop-Up Tools

**Live Trend** - User can see current values from the controller. The list of variables available is preselected based on the configuration of the unit.

**Unit Display** - Mimics the unit controller display. Allows the user full access to the controller without having to physically be at the unit.

**Dewpoint Calculator** - A calculator with three sliders to determine the dew point, temperature, or humidity. Two of the three values are necessary to get the third.

**Upgrade Application** - A new application program can be loaded to the controller via the WebUI.



Web User Interface

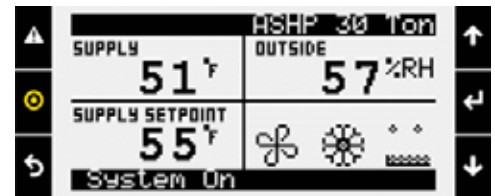

2 Button Click 2 Button Hold

Unit Display



Web User Interface

Logged in with Service, red boxes will appear after logging in.

# Main Menu Navigation

## Unit Enable

## Main Status

- ↳ Unit Status
  - ↳ Input Output Status
- Note:**  
Additional status screens are displayed depending on unit configuration. Screens may include, but are not limited to:
- Occupancy
  - Damper positions
  - Fan status
  - Airflow
  - Setpoints
  - Economizer
  - Energy recovery
  - Cooling
  - Circuit pressure
  - Heating
  - Dehumidification
  - Static pressure



## Ctrl Variables

- ↳ Temp Control
  - ↳ Dehumidification
  - ↳ Refrigeration
    - ↳ Compressor Control
    - ↳ Pressure Control
    - ↳ Heat Pump Control
  - ↳ Economizer
  - ↳ Damper Control
  - ↳ Energy Recovery
  - ↳ Fan Control
    - ↳ Supply Fan Control
    - ↳ Exhaust Fan Control
  - ↳ Occupancy
  - ↳ Advanced
    - ↳ Login
    - ↳ Manual Overrides
    - ↳ Adv. Setpoints\*
    - ↳ PID Tuning\*
    - ↳ Network Settings
    - ↳ Backup/Restore
    - ↳ IO Status/Offset\*
    - ↳ IO Config
    - ↳ Unit Config\*
      - ↳ Service Config
      - ↳ Factory Config
    - ↳ Unit Settings\*
    - ↳ Service Info\*
    - ↳ Alarm Management
      - ↳ Shutdown Alarms
      - ↳ General Alarms
- Note:**  
The Advanced menu is read-only. The service password is required to change these settings. Reference the Advanced menu section for more information.
- \*Consult factory for more information.

## Alarm Menu

- ↳ Alarm History
- ↳ Active Alarms
- ↳ Reset History
- ↳ Clear History
- ↳ Export History

## Unit Status Overview

The microprocessor controller will revert to a default main menu loop. This loop includes several screens to view the operating conditions of the unit. Scroll through the menu screens by using the   buttons.

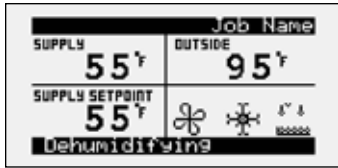







**THE INITIAL MENU SCREEN DISPLAYS THE JOB NAME, UNIT TAG, UNIT STATUS, OUTSIDE AIR CONDITIONS, SPACE CONDITIONS AND SETPOINTS.**

Possible modes include:

- Standby
- Remote Off (S1 Open)
- ER Defrost Active
- Unoccupied Start
- System Shutdown Alarm
- Overrides Active
- Occupied Start
- Pressurization Only
- Expansion Offline
- Opening Dampers
- Exhaust Only
- Energy Recovery
- Dampers Open
- Fans Only Purge
- Hot Gas Reheat Active
- Fan Start Delay
- Case Heat Active
- Morning Seq Active
- Exhaust Fan Start
- Fans Only
- HP Defrost Active
- Supply Fan Start
- Economizing
- Winter Ramp Active
- Startup Delay
- Cooling
- A2L Refrigerant Leak Alarm
- System On
- Heating
- A2L Refrigerant Leak Alarm Fan Only Mode
- Soft Shutdown
- Dehumidifying
- System Disabled
- HGRH Purging

### Unit Status Screen Symbols

Symbol	Indicates	Symbol	Indicates
	Supply air fan status. Rotation indicates airflow; static blades indicate no airflow.		Dehumidifying
	Cooling		Economizing
	Heating		Defrosting

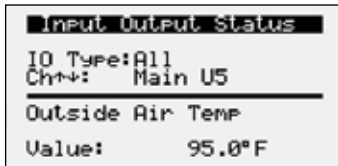

### INPUT OUTPUT STATUS

Displays real time conditions from sensors located in the unit and building space if equipped with space mounted sensors. Controller output conditions can also be viewed from this screen. To view the desired input/output point, the user must select the desired channel. Reference the unit schematics for individual point locations.

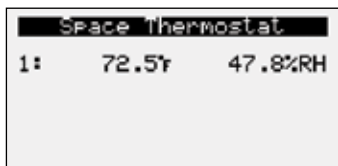

### SPACE THERMOSTAT STATUS

This screen displays the current temperature and relative humidity for up to four space thermostats that are communicated to the controller via Modbus.

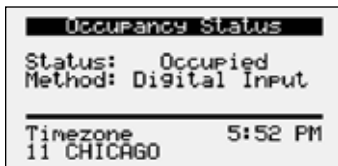

### OCCUPANCY STATUS

Displays current status of occupancy and the configured occupancy control method and time zone.



### DAMPER COMMANDED POS

This screen appears if equipped with modulating OA and recirculated air dampers. Displays current commanded position of the outside damper and recirculated air damper, if equipped.

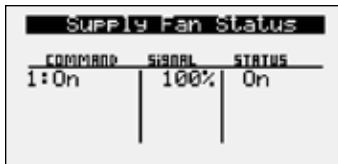

### SUPPLY FAN STATUS

This screen displays the fan enable command, fan proving status, and the supply fan ramp being sent from the controller to the VFD. The controller can modulate the fan between the min and max speeds.

## Unit Status Overview

```
SUPPLY Fan VFD Status
Address(21): Online
Speed: 2458rpm 95hz
Current: 7.40A
Output: 473V
ENTER for VFD Details
```

```
Exhaust Fan Status
COMMAND SIGNAL STATUS
1:On | 100% | On
```

```
Airflow Status
Supply Fan: 0 cfm
Exhaust Fan: 0 cfm
Outside Air: 0 cfm
```

```
Ambient Lockout Status
Heating: Allowed
Cooling: Allowed
Economizer: Allowed
HP Heating: Allowed
Preheat: Disabled
Outside Temp: 70.0F
```

```
Outside Reset
Outside Temp: 95.0F
Supply Spt: 55.0F
Active Spt: 55.0F
```

```
Active Reset
Supply Temp: 70.0F
Supply Spt: 72.0F
Cooling Spt: 74.0F
Heating Spt: 70.0F
Active Spt: 72.0F
```

```
Supply Setpoint
Supply Temp: 71.5F
Setpoint: 72.0F
```

```
Economizer Ramp
Setpoint: 72.0F
Temp: 71.5F
RAMP: Disabled 0%
Mode:
Outside Dry Bulb
```

```
Case Heat
Setpoint: 40.0F
Case Temp: 76.8F
RAMP: Enabled 0%
```

### MODBUS CONTROLLED FAN

This screen appears if equipped with a Modbus controlled VFD. This screen displays the fan speed, current, torque, bus voltage, output voltage and power consumption being sent from the VFD to the controller. Press enter key for additional fan operation detail.

### EXHAUST FAN STATUS

This screen displays the fan enable command, fan proving status, and the exhaust fan ramp being sent from the controller to the VFD. The controller can modulate the fan between the min and max speeds.

### AIRFLOW STATUS

This screen displays the current airflow volumes if the unit is provided with airflow monitoring. Supply Fan, Exhaust Fan, and Outside Air airflow are optional monitoring sensors that will appear when installed.

### AMBIENT LOCKOUT STATUS

Displays the lockout status for heating, cooling, economizing, preheat, and heat pump heating based on the outside air ambient temperature. Ambient lockouts for heating and cooling can be altered by entering Main Menu/Ctrl Variables/Temp Control.

### OUTSIDE RESET

This screen will be active if the controller is configured for outside air reset. The heating and cooling devices modulate to maintain the supply air temperature setpoint as determined by the outside reset calculation.

### ACTIVE RESET

This screen will be active if temperature control mode is set for space or return air reset. The supply temperature setpoint is calculated based on the active setpoint and the current space or return temperature. The calculated setpoint is scaled between the supply temperature min and max setpoints determined by the current mode of operation.

### SUPPLY SETPOINT

This screen is active when supply temp control is selected or the active mode of control. Displays current supply temperature and supply temperature setpoint to be achieved.

### ECONOMIZER RAMP

The economizer ramp screen will be active if the unit is configured for economizer control. This screen displays the economizer setpoint, supply air discharge temperature, economizer ramp status, and economizer control mode. Economizer control mode options include, outside dry bulb, outside enthalpy, comparative dry bulb, and comparative enthalpy.

### CASE HEAT

When the unit is off or in standby, the hot water valve will be modulated to maintain the case temperature to the case heat setpoint.

## Unit Status Overview

```

CO2 RAMP OUTPUT
Setpoint:      1000PPM
CO2 Level:     0PPM
Ramp: Disabled  0%
    
```

### **CO<sub>2</sub> RAMP OUTPUT**

The CO<sub>2</sub> Ramp Output screen will be active if the unit is configured for CO<sub>2</sub> control. This screen displays the CO<sub>2</sub> setpoint, CO<sub>2</sub> level from the space, and the status of the control ramp.

```

Energy Recovery
Status:        Disabled
Ramp:          0%
Bypass Damper: 100%
    
```

### **ENERGY RECOVERY STATUS**

This screen provides overall status of the energy recovery device. The device installed, heat wheel, face damper, or bypass damper will appear with the speed or position of the device.

```

ER Defrost
Setpoint:      25.0°F
Exhaust Temp:  70.0°F
Outside Temp:  70.0°F
Press Switch:  Defrost
Ramp:          0%
    
```

### **DEFROST RAMP OUTPUT**

This screen only appears if the unit has energy recovery, and a frost control method was provided on the unit.

If the energy recovery device is a polymer wheel, the state of the wheel high differential pressure switch will be displayed.

Upon sensing a high differential pressure across the energy wheel, the unit will go into defrost if the outside air temperature is below the defrost temperature setpoint.

```

Preheat
Damper Setpt:  30%
OA Damper:     0%
Preheat:       Inactive
    
```

### **PREHEAT STATUS**

This screen displays the position of the Outside Air Damper and whether the preheater is active or inactive. When the outside air damper is modulating, the damper setpoint for the preheater is also displayed.

*Modulating OA Damper*

```

Preheat
OA Damper:     Closed
Preheat:       Inactive
    
```

*100 % Outside Air*

```

Cooling Ramp 1
Setpoint:      72.0°F
Supply:        71.5°F
Ramp: Enabled  27%
Capacity:      27%
Press ENTER for detail
    
```

### **COOLING RAMP 1**

This screen displays the active setpoint, supply discharge temperature, cooling enable/disable, cooling ramp being sent from the controller, and the overall capacity being demanded.

```

HP Heating Ramp
Setpoint:      72.0°F
Supply:        54.1°F
Ramp: Disabled  0%
Capacity:      0%
Press ENTER for detail
    
```

### **HEAT PUMP HEATING RAMP**

The Heat Pump Heating Ramp status screen is active when the unit is configured as a heat pump. The screen displays the active setpoint, supply temperature, status of the heat pump heating control ramp, the current ramp percentage, and the current capacity of the operating compressors.

```

Compressor Request
COMPRESSOR  RAMP  CIRCUIT
1:On  26%  1  A
    
```

### **COMPRESSOR REQUEST**

The compressor request screen will be active if the unit is equipped with DX cooling. This screen displays overall status of individual compressor operation being sent from the unit controller. Example: Circuit A compressor enable (On) with modulating value of 26%.

## Unit Status Overview

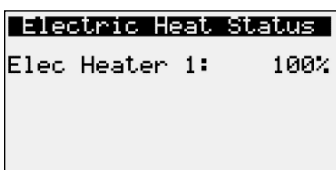
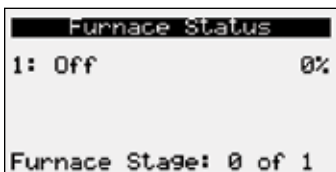
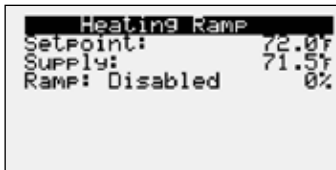
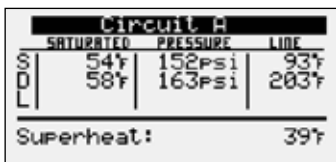
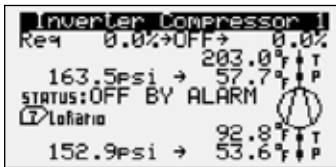
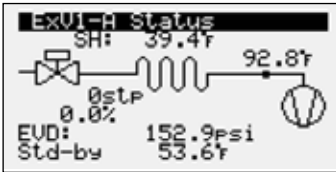

### ExV STATUS

The ExV Status screen is active when the unit is equipped with an inverter scroll compressor and electronic expansion valve (ExV). The screen displays information from the EVD (electronic valve driver) including the number of steps (stp) of the valve, the open percentage of the valve, the EVD control status, the suction superheat, the suction temperature, the suction pressure, and the saturated suction temperature. The second status screen also displays the capacity of the circuit the valve is installed on and the discharge refrigerant temperature for that circuit.

### INVERTER COMPRESSOR STATUS

The inverter compressor screen is active when an inverter scroll compressor is installed in the unit. This screen displays information about the operation of the inverter scroll starting with the requested capacity of the compressor compared to its actual operating capacity. The requested capacity and the actual could be different at startup and depending on where it is in the operating envelope. The status of the compressor, current envelope zone and current refrigerant temperatures and pressures are also displayed. Press enter key for additional inverter compressor detail.

### CONDENSER FAN STATUS

The pressure control status screen is active when a unit is equipped with active head pressure control. This screen provides information regarding the outside fan ramp status, circuits affected by the ramp, the status of the fans, the set point, offset and current saturated temperature.

### REFRIGERANT CIRCUIT STATUS

The refrigerant circuit status screen is active when the unit is equipped with active head pressure control. This screen provides temperatures and pressures for suction and discharge sensors, when installed. Superheat is also displayed when suction temperature and pressure sensors are installed.

### HEATING RAMP

This screen displays the active setpoint, supply air temperature, status of the heating control ramp, and heating ramp being sent from the controller.

### FURNACE STATUS

This screen displays the status of the furnace(s) installed in the unit. One modulating with up to two additional fixed stage furnaces will show the status of each furnace. The status of each furnace tells what mode of operation the furnace is currently in. The number of furnace stages on and the total number of stages appear at the bottom of the screen.

### ELECTRIC HEAT STATUS

This screen displays the status of the electric heat installed in the unit.

## Unit Status Overview

```
Dehumidification
Status: Enabled
Based On:
OAT > Coil Set+Offset

Overcooled: No
Enable Delay: 0s
```

### DEHUMIDIFICATION

This screen will display the overall dehumidification status and selected dehumidification control mode.

The following dehumidification modes are available when the space is in occupied mode:

- Cold coil setpoint plus offset (10°F)
- Inside RH\*
- Inside dew point\*
- Outside dew point
- Inside RH or inside dew point\*
- Inside RH or inside dew point or outside dew point
- Inside RH and inside dew point\*
- Inside RH and inside dew point or outside dew point

\*Available during unoccupied mode.

```
HGRH Ramp
Setpoint: 72.0f
Supply Temp: 76.8f
RAMP: Disabled 100%
Active:
```

### HGRH RAMP

This screen will display the status of the hot gas reheat ramp. The screen includes the active setpoint, supply air discharge temperature, the ramp status, and hot gas reheat valve request being sent from the controller.

```
Dehum Coil Reset
Setpoint: 55.0%rh
Space RH: 33.0%rh
Coil Setpt: 55.0f
Current Mode:
Indoor RH
```

### DEHUMIDIFICATION COIL RESET

This screen displays information on the dehumidification coil reset control.

When dehumidification cooling coil reset is enabled, this screen will appear with additional information about the space or return humidity, the setpoint, and the current coil setpoint.

```
SUPPLY SPACE STATIC
Output: 0.0%
Static: 0.000"wc
Setpoint: 0.050"wc
```

### SUPPLY SPACE STATIC

This screen displays status points if the unit is configured for space static pressure control. Status points include controller output ramp, static pressure in the space, and the space static pressure setpoint. Similar status screens appear for exhaust fan and outside air damper control if the unit is configured.

```
SUPPLY DUCT STATIC
Output: 0.0%
Static: 0.000"wc
Setpoint: 1.000"wc
```

### SUPPLY/RETURN DUCT STATIC

This screen displays status points if the unit is configured for duct static pressure control. Status points include controller output ramp, static pressure in the duct, and the duct static pressure setpoint. Similar status screen will appear for the exhaust fan if the unit is configured for exhaust fan duct static control.



```
Outside Air Conditions
Temp: 51.8f
Humidity: 61%
Enthalpy: 17.9btu/lb
DewPoint: 38.6f
```

### CONDITIONS

The condition screens are active when both temperature and humidity sensors for the location are installed in the unit. The enthalpy and dew point are calculated based on the temperature and humidity readings. The unit altitude is used for the enthalpy calculation.

```
Space Conditions
Temp: 71.6f
Humidity: 80%
Enthalpy: 31.9btu/lb
DewPoint: 65.2f
```

## Menu

The controller is equipped with several menus to help guide users with altering program parameters. The following menus can be accessed by pressing the  button. To enter the desired menu, press the  button.

### Unit Enable

The **Unit Enable** menu allows the user to enable and disable the unit through the controller. Reference sequence of operation for additional unit starts/stop details.

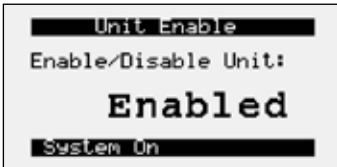

#### CHANGE UNIT ENABLE

This screen allows the user to manually turn the unit on or off via display.

Note: The unit is shipped disabled from the factory. **To start the unit, a field-wired jumper or fire switch must be installed at S6 for the Building Fire Alarm input.** The factory-installed jumper may be replaced with a switch at S1 for the Remote Start input. Refer to unit wiring diagram for more information.

### Control Variables

The **Control Variables** menu allows the user to view and adjust unit control parameters.

#### Control Variables

 Temp Control

The **Temperature Control** menu allows the user to view and adjust temperature control conditions of the unit. Economizer setpoint adjustment is also found at this location if the unit is equipped with outside air and recirculation dampers.

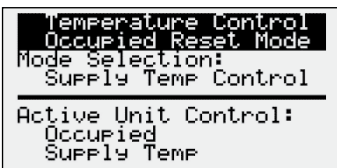

#### RESET MODES FOR TEMPERATURE CONTROL

Reset Mode selections are available for both occupied and unoccupied operation. Unoccupied Reset Mode is available when Unoccupied Reset Mode is selected to Normal Operation or Recirculation with Unoccupied Setpoints. The Unoccupied Reset Mode will hide when Night Setback or Off is selected for Unoccupied Unit Operation.

#### Setpoint Selections:

**Supply Temp Control** – The supply discharge setpoint is a constant value (e.g. 72°F). Reference Temperature Setpoint screen for setpoint adjustment.

**Space Reset** – The controller will reset the supply air temperature setpoint to maintain the space temperature setpoint (requires space temp sensor). Reference the Temperature Setpoint screen for space setpoint adjustment.

**Return Reset** – The controller will reset the supply air temperature setpoint to maintain the return air temperature setpoint (requires duct mounted return air temp sensor). Reference the Temperature Setpoint screen for return air setpoint adjustment.

**OA Reset** – The controller monitors the OA temperature and adjusts the desired supply temperature setpoint accordingly. For example, when the OA is below 55°F, the controller will change the supply setpoint to 70°F. If the OA is above 65°F, the controller will change the supply setpoint to 55°F. If the OA temperature is between 55°F and 65°F, the supply setpoint changes according to the OA reset function. A visual representation of the OA reset function is shown below. Reference Outside Setpoints for min and max outside air limits.

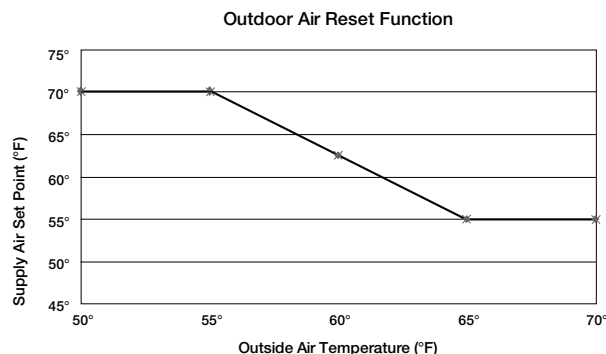

```

Temperature Control
Occupied Temp Reset
Setpoint:      72.0°F
Deadband:      4.0°F
-----
Cooling Spt:   74.0°F
Heating Spt:   70.0°F
    
```

```

Temperature Control
Occupied Supply Temp
Setpoint:      78.0°F
-----
Supply temp control
setpoint during
occupied operation.
    
```

```

Temperature Control
Unoccupied Temp Reset
Setpoint:      70.0°F
Deadband:      20.0°F
-----
Cooling Spt:   80.0°F
Heating Spt:   60.0°F
    
```

```

Temperature Control
Unoccupied Supply Temp
Setpoint:      65.0°F
-----
Supply temp control
setpoint during
unoccupied operation.
    
```

```

Temperature Control
Cooling Reset Limits
Maximum:       90.0°F
Minimum:       55.0°F
-----
Min & max reset values
Occupied & Unoccupied
    
```

```

Temperature Control
Heating Reset Limits
Maximum:       90.0°F
Minimum:       55.0°F
-----
Min & max reset values
Occupied & Unoccupied
    
```

```

Temperature Control
Unoccupied Hysteresis
Cooling:       5.0°F
Heating:       5.0°F
-----
Hysteresis to turn off
for Night Setback.
    
```

```

Temperature Control
Outside Reset
OR Temp      Setpt
55.0°F >>>  90.0°F
65.0°F >>>  55.0°F
-----
Supply Setpt: 55.0°F
    
```

```

Temperature Control
Mode Switch Delay
Delay:        120s
-----
Delay before switching
between heating and
cooling modes.
    
```

**TEMPERATURE SETPOINT**

One of the setpoint screens appears when supply temp control, space reset, or return reset is selected as the reset control mode.

**Setpoint Selections:**

**Local** – The space setpoint will be constant; set from screen (e.g. 72°F).

**BMS** – The BMS can directly control the space temperature setpoint (requires BMS communication option).

**T-Stat** – The space setpoint will be adjustable from the space thermostat.

Reference Appendix: Space Thermostat Quick Start for additional information.

**Deadband:**

When space reset or return air reset is selected, the setpoint and deadband screen appears. The deadband allows for separate cooling and heating setpoints.

**UNOCCUPIED TEMPERATURE SETPOINT**

The unoccupied temperature reset and supply temperature setpoint operation works the same as occupied when the unoccupied unit operation is selected as Normal operation with unoccupied setpoints or Recirculation with unoccupied setpoints.

When night setback cycle is selected, please see the sequence of operation for Setpoint Control (Night Setback) section.

**TEMPERATURE RESET SETPOINTS**

Cooling and heating supply setpoints screens only appear if outdoor reset, space reset, or return air reset is selected. These screens allow the user to set the min and max setpoint limits for cooling or heating operation. The controller will adjust the supply temperature setpoint between the set limits depending on mode of operation.

**UNOCCUPIED HYSTERESIS**

When the unit is operating in Unoccupied Night Setback, the sequence uses a hysteresis added(heating) or subtracted(cooling) from the setpoint to turn the unit back off.

**OUTSIDE RESET SETPOINTS**

This screen only appears if outside reset is selected as the reset control mode.

**MODE SWITCH DISPLAY**

This screen displays the delay time required before switching between heating and cooling mode.

```

Temperature Control
Startup Delay
Delay:                30s
-----
Delay before enabling
unit ctrl at startup.
    
```

**STARTUP DISPLAY**

This screen displays the delay time after the fans have started and tempering begins.

```

Temperature Control
Cooling
Amb Lockout:         55.0°F
-----
Outside Temp:       70.0°F
Currently Allowed
    
```

**COOLING LOCKOUT**

This screen displays the cooling lockout temperature. Cooling will be disabled when outside air is below the cooling lockout temperature (55°F).

```

Temperature Control
Heating
Amb Lockout:         80.0°F
-----
Outside Temp:       70.0°F
Currently Allowed
    
```

**HEATING LOCKOUT**

This screen displays the heating lockout temperature. Heating will be disabled when outside air is above the lockout temperature (80°F).

```

Temperature Control
Winter Ramp
Enable:              No
Mode:                Supply Fan
OAT Enable:          40.0°F
    
```

**WINTER RAMP**

The winter ramp function prevents the supply temperature from dropping below setpoint under the following conditions:

- Outside air temperature is below the winter ramp enable setpoint; and
- Heating capacity is at 100%

One of the following is used to perform the winter ramp function:

- Supply fan speed; or
- Outside air damper position

Note: If the unit is a heat pump, the supply fan is always used.

```

Temperature Control
Case Heat
Setpoint:            40.0°F
-----
Uses Hot Water Valve
To maintain Coil/Mixed
temp in unit off mode.
    
```

**CASE HEAT**

The case heat function allows the use of the hot water valve modulation to maintain the temperature of the case when the unit is off or in standby mode.

Case heat can be disabled with the service password in Ctrl Variables/Advanced/Adv. Setpoints.

```

Temperature Control
Space Thermostat
Quantity:            1
    
```

**MODBUS SPACE T-STAT**

The quantity of thermostats installed in the space that communicate the temperature, humidity, and setpoint to the controller. The controller averages the temperature and humidity readings when there is more than one installed. See Appendix C for more information.

## Control Variables

↳ Dehumidification

```

Cold Coil Setpoint
Reset Mode:      None
Coil Setpoint:  50.0°F

-----
Current Mode:
None - Fixed Setpoint
    
```

```

Dehumidification Mode
Occupied Mode
Dehumidify when:
Indoor RH > 55%RH
OR
Indoor Dewpt > 55.0°F
OR
Outside Dewpt > 60.0°F
    
```

```

Dehumidification Mode
Unoccupied Mode
Dehumidify when:
Indoor RH > 60%RH
OR
Indoor Dewpt > 55.0°F
    
```

```

Dehumidification
Occupied Hysteresis
Humidity:      4.0%RH
Dewpoint:      2.0°F

Unoccupied Hysteresis
Humidity:      5.0%RH
Dewpoint:      2.5°F
    
```

```

Dehumidification Mode
On Delay:      2m
Minimum On time: 15m
    
```

The **Dehumidification** menu allows the user to view and adjust dehumidification control parameters.

### **COLD COIL SETPOINT**

When an indoor humidity sensor or temperature and humidity sensors (space or return) are installed, the controller can adjust the cold coil leaving air temperature setpoint between the minimum (50°F) and maximum (55°F) setpoint. This function can be enabled or disabled by selecting the reset mode for the setpoint. If the indoor sensor becomes unavailable, the reset mode will become None until the sensor becomes available.

#### **Reset Mode:**

- None: The setpoint will remain static (50°F). This is the default when a space or return humidity are not.
- RH: The setpoint will reset based on the indoor humidity.
- Dewpoint: The setpoint will reset based on the indoor dew point.

### **DEHUMIDIFICATION MODE - OCCUPIED**

#### **Possible Modes:**

- Outside Air Temp is greater than cold coil setpoint plus offset (10°F)
  - Inside RH\*
  - Inside dew point\*
  - Outside dew point
  - Inside RH or inside dew point\*
  - Inside RH or inside dew point or outside dew point
  - Inside RH and inside dew point\*
  - Inside RH and inside dew point or outside dew point
- \*Available during unoccupied mode.

There must be a constant call for dehumidification for the duration of the enable delay for dehumidification mode to become enabled. The call remains active until conditions are satisfied and dehumidification mode has been active for the min active time. Reference Ctrl Variables/Advanced/Unit Config/Unit Configuration Occupied Dehum Call for dehumidification method options.

### **DEHUMIDIFICATION MODE - UNOCCUPIED**

If the unit is unoccupied while there is a dehumidification call, the unit will start and dehumidify until the unoccupied dehumidification setpoints are satisfied. The above dehumidification modes marked with an \* indicate availability during unoccupied mode. The unoccupied dehumidification mode can be set differently than the occupied dehumidification mode. Reference Ctrl Variables/Advanced/Unit Config/Unit Configuration Unoccupied Dehum Call for dehumidification method options.

### **DEHUMIDIFICATION HYSTERESIS**

This screen displays hysteresis for enabling dehumidification during occupied and unoccupied conditions. %RH for indoor RH control and °F for indoor dew point control. Example: If indoor RH setpoint = 50%, dehumidification is enabled when indoor RH equals 50% and above. Dehumidification is disabled when indoor RH is below 46%.

### **DEHUMIDIFICATION TIMERS**

This screen allows adjustment for delay and minimum on time for dehumidification mode. Times are in place to prevent short cycling between dehumidification and other control modes.

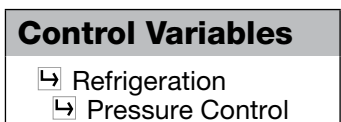
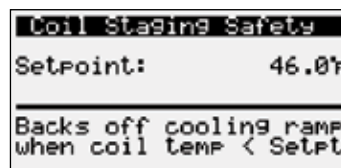
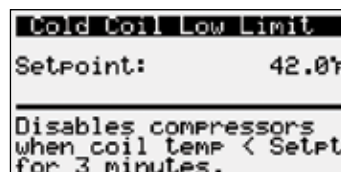
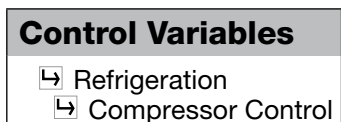
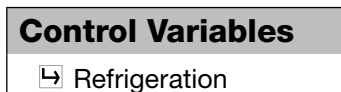
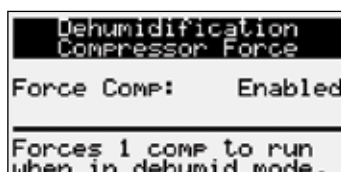
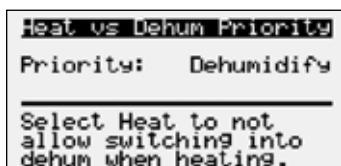
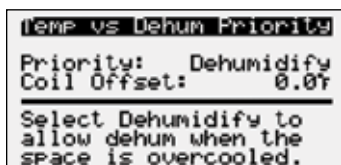
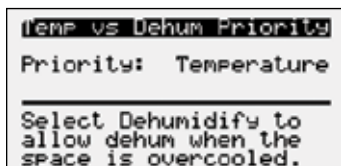

## DEHUMIDIFICATION PRIORITY

The following screens are used to determine what mode of operation is priority: temperature over dehumidification or heating over dehumidification.

Both priority selections determine when the unit is allowed to dehumidify.

### 1. Temperature vs Dehumidification

Determines when the unit is allowed to dehumidify based on the space/return air temperatures. This screen will only appear if the temperature mode selected is space or return reset.

**a. Temperature** - If temperature is set as the priority, box checked, and the space or return air is over cooled, dehumidification is locked out until the space or return temperature is no longer overcooled.

**b. Dehumidification** - If the priority is dehumidification, box not checked, and the space or return air is over cooled, the coil offset will be added to the coil leaving setpoint. (Default 0°F offset).

**c. Overcooled** - If space or return reset is enabled, the target is considered over cooled when it is 4°F below setpoint for 5 minutes. It remains over cooled until the target is at setpoint and the over-cool logic has been active for 5 minutes.

### 2. Heating vs Dehumidification

Determines when the unit is allowed to dehumidify when heating is active.

**a. Heating** - If priority is heat, the unit locks out dehumidification while heating is active.

**b. Dehumidification** - If priority is dehumidify, the unit is allowed to switch to dehumidification when heating is active.

## COMPRESSOR DEHUMIDIFICATION FORCE

In dehumidification mode, the lead compressor will continue to run when the dehumidification mode sequence is enabled to prevent compressor cycling and potential re-evaporation of moisture. To disable this operation and allow the compressor to cycle in dehumidification mode, uncheck the applicable cooling ramps.

The **Refrigeration** menu allows the user to view and adjust compressor and condenser settings, if equipped.

## COMPRESSOR CONTROL

Consult factory prior to adjusting parameters in the compressor control menu.

## COLD COIL LOW LIMIT

This screen displays the Cooling Coil Low Limit setpoint. Compressors will disable if the cooling coil temperature drops below this setpoint for three minutes and will stay disabled until the temperature reaches the Coil Staging Safety Setpoint.

## COLD COIL STAGING SAFETY

This screen shows the Coil Staging Safety setpoint. If the cooling coil temperature falls below this setpoint, additional compressors will not be enabled, regardless of tempering needs

## PRESSURE CONTROL

Consult factory prior to adjusting parameters in the pressure control menu.

**Control Variables**

- ↳ Refrigeration
- ↳ Heat Pump Control

```

ASHP Heating
Low Ambient
Lockout:      10.0°F
Currently Allowed
    
```

```

Heat Pump Defrost
Cancel Setpt: 80.0°F
Max Time:     5m
SDT > Cancel Defrost
or defrosting longer
Time = Stop Defrost
    
```

**Control Variables**

- ↳ Economizer

```

Economizer Control
Selected Mode:
Disabled
Active Mode:
Disabled
    
```

```

Economizer Control
Outside Dry Bulb
Economize when:
Temperature > 40.0°F
AND
Temperature < 65.0°F
Act Mode: OA Dry Bulb
    
```

```

Economizer Control
OA Enthalpy & Dry Bulb
Economize when:
Temperature > 40.0°F
AND
Temperature < 65.0°F
AND
Enthalpy < 23.0btu/lb
    
```

```

Economizer Control
Comparative Dry Bulb
Economize when:
Outside Temp > 40.0°F
AND Outside < Indoor
70.0°F < 69.9°F
Act Mode:Comp Dry Bulb
    
```

```

Economizer Control
Comparative Enthalpy
Economize when:
Outside Temp > 40.0°F
AND Outside < Indoor
25.4 < 22.6btu/lb
Act Mode:Comp Enthalpy
    
```

```

Economizer Control
Hysteresis
Temperature: 2.0°F
Enthalpy: 2.0btu/lb
    
```

**COMPRESSOR CONTROL**

Allows the user to adjust heat pump heating control setpoints.

**AIR-SOURCE HEAT PUMP AMBIENT LOCKOUT**

The screen allows the user to adjust the minimum ambient temperature the compressors can be utilized for heating. When the outside air temperature drops below this temperature, heating with the compressors will not be allowed.

**HEAT PUMP DEFROST**

Consult factory prior to adjusting setpoints related to heat pump defrost operation.

The **Economizer** menu allows the user to view and adjust economizer control parameters. The economizer menu appears when the economizer function is enabled.

**ECONOMIZER MODE**

The user can select the economizer control method desired for the unit. The screens show the setpoints that are active to enable economizer function.

Economizer Ambient Lockout – Economizing is allowed when the outside dry bulb is greater than the first economizer temperature setpoint. (40°F).

The ambient lockout is always used to enable economizer along with one of the following selections:

**Mode Selections:**

- **Outside Dry Bulb** – Economizing is allowed when the outside dry bulb is less than the second economizer temperature setpoint (65°F).
- **Outside Enthalpy** - Economizing is allowed when outside enthalpy is less than the economizer enthalpy setpoint (23/btu/lb).
- **Outside Enthalpy & Dry Bulb** - Economizing is allowed when outside enthalpy is less than the enthalpy set point (23btu/lb) and the outside temperature is less than the temperature set point (65°F).
- **Comparative Dry Bulb** - Economizing is allowed when outside temperature is less than the space or return temperature.

**ECONOMIZER HYSTERESIS**

There is a built-in hysteresis that disables economizer above the economizer setpoint.

(Example: If economizer outside dry bulb = 65°F, economizer operation is disabled above 67°F).

```

Economizer Control
Energy Rec/OA Damper
Device:      OAD & ER
Opens OAD & Reduces ER
-----
Selects which devices
are controlled by Econ
    
```

```

Economizer Control
Energy Rec/OA Damper
Device:      ER Only
Reduces ER Only
-----
Selects which devices
are controlled by Econ
    
```

**Control Variables**

↳ Damper Control

```

Fan Damper Delay
Delay:      30s
-----
Time allowed for the
damper to open prior
to allowing fans to
run.
    
```

```

Outside Air Damper
Range Limit
Supply Fan: Disabled
-----
Changes upper & lower
limits of OAD based
on the supply fan.
    
```

```

Outside Damper
Occupied
Minimum:    35%
Maximum:    100%
    
```

```

Outside Damper
Occupied
Minimum:    35%
CO2 Maximum: 50%
Maximum:    100%
    
```

```

Outside Damper
Occ Supply Fan Reset
SF Speed 50%--> 100%
-----
Minimum: 35%--> 20%
CO2 Maximum: 50%
Maximum: 100%--> 100%
    
```

```

Outside Damper
Occ Supply Fan Reset
SF Speed 50%--> 100%
-----
Minimum: 35%--> 20%
CO2 Maximum: 50%
Maximum: 100%--> 100%
    
```

**ECONOMIZER DEVICE CONTROL**

This screen determines what devices in the unit the economizer function utilizes. The option to have the outside air damper and energy recovery devices both affected by economizer or the only energy recovery device in 100% outdoor air units.

**OAD** – Indicates that the Outside Air Damper position will be affected by the economizer ramp. The outside air damper will modulate between the min and max position to maintain the supply temperature setpoint.

**ER** – Indicates that the Energy Recovery wheel speed or Core bypass damper position will be affected by the economizer ramp. When the economizer control is set to ER, the energy recovery speed is reduced, or the bypass damper is opened to ensure no energy is transferred from the supply airstream and exhaust airstream.

The **Damper Control** menu allows the user to adjust damper control setpoints.

**FAN DAMPER DELAY**

This screen allows adjustment for delay time between damper opening and fan operation. This timer allows the damper to open before the fan start sequence begins. This prevents the fans from having to overcome higher static pressure when the damper(s) are opening.

**OAD SF RESET**

This screen only appears if equipped with a modulating OA damper. Checking the box will allow the outside air damper to modulate between the min and max positions proportionally based on the supply fan speed.

**OUTSIDE DAMPER POSITION - OCCUPIED**

This screen only appears if equipped with a modulating OA damper. The screen displays the min and max positions for the outside air damper. These setpoints reflect the percentage of the outside air damper being opened.

- 0% = Full recirculation air
- 100% = Full outside air

\*Note: If the unit is equipped with a modulating OA damper but intended to be 100% outside air, the minimum and maximum should both remain at 100%.

**Minimum Position** – When in the occupied mode, the active setpoint will be equal to a local minimum OA setpoint, which may be constant or reset by fan speed if equipped with a modulating supply fan.

**Maximum Position** – Each sequence that can adjust the OA damper setpoint contains a max position to prevent excess OA. The active setpoint will be determined based on the greatest demand of the configured sequences.

The OA damper setpoint can then be further adjusted between the minimum and maximum OA settings with sequences such as CO<sub>2</sub>, Building Pressure and Economizer.

**Setpoint Selections:**

**Constant Position** – The min OA percentage is constant; set by the controller.

**SF Reset** – The min and max positions are reset by the supply fan speed.

**BMS** – The BMS can directly control the OA damper position between the min and max percentages.

**Building Pressure** – Damper position is reset by a building pressure control loop.

**CO<sub>2</sub>** – Damper position is reset by a demand-controlled ventilation control loop

## Menu

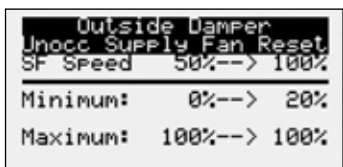
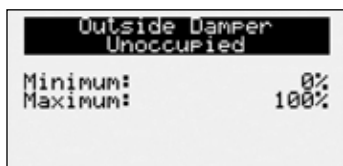
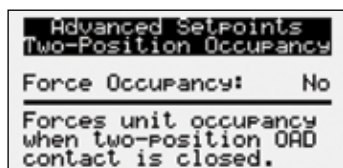

### Control Variables

↳ Energy Recovery

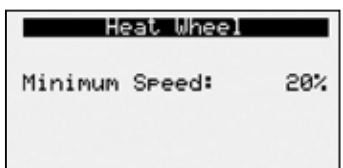

based on space CO<sub>2</sub> levels. The CO<sub>2</sub> max is the highest percentage that the OA damper can modulate when solely based on CO<sub>2</sub>.

**2 Position** – Damper sequence that utilizes a contact closure to determine which position the OA damper is commanded to minimum or maximum. The “Max Vent” contact closure maybe be field configured to temporarily force the unit into occupied mode. Reference Ctrl Variables/Advanced/Advanced Setpoints/Max Vent to enable this option.

**0-10 By Others** – The 0-10V signal directly correlates to the damper position of 0-100%. When the signal is below the minimum damper position setpoint, the damper will modulate to minimum position. When the signal is above the maximum damper position setpoint, the damper will modulate to max position.

### **OUTSIDE DAMPER POSITION - UNOCCUPIED**

Occupied and unoccupied damper control have minimum and maximum set points for the specific mode of operation. Unoccupied OA Damper control typically will only show the minimum set point. The maximum will also appear if the OA Damper is controlling to building pressure.

The **Energy Recovery** menu allows the user to adjust energy recovery device sequence setpoints.

### **DEFROST RAMP**

This screen displays the temperature at which the unit will enable frost control mode if necessary. The factory default is dependent on the energy recovery device installed. This screen only appears if the unit has energy recovery and a frost control method was selected.

Max active time and min off time will be available if the frost control method selected was timed exhaust.

### **ENERGY RECOVERY DEFROST PREHEAT LOCKOUT**

Preheat is not allowed when the outside air temperature is above the lockout temperature (10°F).

### **ENERGY RECOVERY DEFROST PREHEATER MINIMUM DAMPER POSITION**

Minimum required outdoor damper position to allow electric preheat operation, ensuring adequate airflow across the electric preheater.

### **ENERGY RECOVERY WHEEL JOG FUNCTION**

This screen displays the energy recovery wheel jog combine to setpoints. This screen only appears if the unit is equipped with an energy recovery wheel.

When the wheel has been disabled for the delay time, the wheel jog function enables the wheel for the duration.

### **ENERGY RECOVERY WHEEL MINIMUM SPEED**

This heat wheel minimum speed screen will appear when the energy recovery device is a modulating wheel. The minimum speed set point determines the minimum speed a modulating wheel can rotate.

## Control Variables

- ↳ Fan Control
- ↳ Supply Fan Control

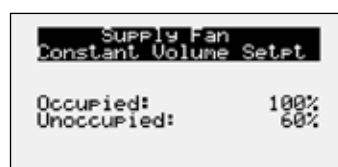
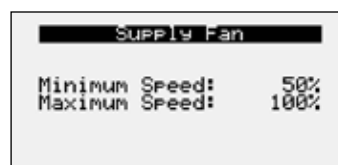

## Control Variables

- ↳ Fan Control
- ↳ Exhaust Fan Control

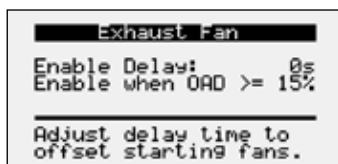

The **Supply Fan Control** menu allows the user to adjust supply control setpoints.

### **SUPPLY FAN DELAY**

The supply fan delay will begin once the damper sequence is complete. This delay can be used to offset starting times between the supply fan and exhaust fan.

### **SUPPLY FAN SPEED**

This screen displays min and max supply fan speed percentages. The speed setpoint is the proportional percentage of the analog output from the controller to the VFD.

50% Speed = Min speed

100% Speed = Max speed

#### **Setpoint Selections:**

**Constant Volume** – The fan speed will be constant; set from screen (e.g. 100%).

**BMS** – The BMS can directly control the fan speed (requires BMS communication option).

**Duct Pressure** – Fan speed is determined by duct pressure control loop.

**Space Pressure** – Fan speed is determined by building pressure control loop.

**CO<sub>2</sub>** – Fan speed is determined by CO<sub>2</sub> control loop.

**Single Zone VAV** - The supply fan is modulated in addition to the supply air temperature to satisfy the space temperature setpoint.

**2-Speed** - Supply fan control utilizes a contact closure to determine which speed the supply fan speed is commanded; minimum or maximum. The “Max Vent” contact closure maybe be field configured to temporarily force the unit into occupied mode. Reference Ctrl Variables/Advanced/Advanced Setpoints/Max Vent to enable this option.

**0-10 Hardwired** – The 0-10V signal hardwired at the controller determines the speed of the fan after the controller sends an enable command to the vfd. When the signal is below the minimum fan speed setpoint, the fan will operate at minimum. When the signal is above the maximum fan speed setpoint, the fan will operate at maximum.

### **SOFT SHUTDOWN ENABLE**

During a soft shutdown the following will occur:

- Tempering outputs immediately revert back to their off value; while
- Dampers remain open and fans continue to run; until
  - The supply air temperature falls below the soft shutdown enable setpoint (85.0°F) minus 5°F; or
  - The soft shutdown delay timer has expired.

The **Exhaust Fan Control** menu allows the user to adjust exhaust control setpoints.

### **EXHAUST FAN DELAY AND ENABLE**

This screen displays the exhaust fan delay and enable based on OA damper position. The exhaust fan delay will begin once the damper sequence is complete. This delay can be used to offset starting times between the supply fan and exhaust fan. This screen also provides the ability to enable the exhaust fan on a set OA damper position if the unit is equipped with a modulating OA damper.

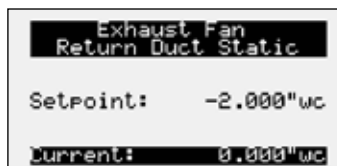
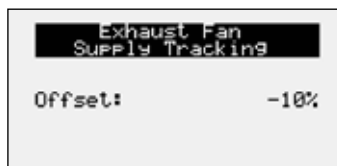
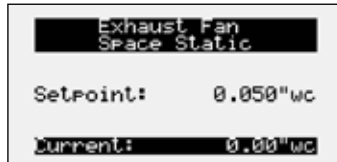
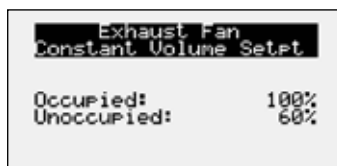
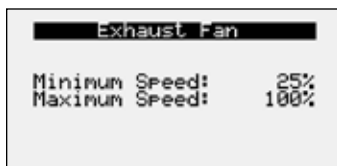
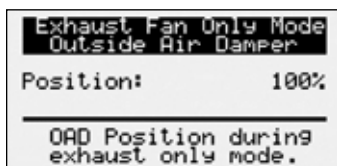

**Control Variables**

↳ Occupancy

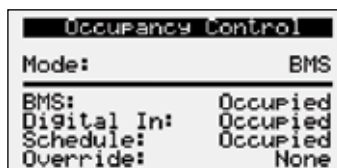

**EXHAUST FAN ONLY OUTSIDE AIR DAMPER**

This screen will appear when the exhaust fan only mode is available at the controller by a contact closure. When the contact is closed, the exhaust fan will run at 100%. The outside air damper will go to this position (100%) when the contact is closed.

**EXHAUST FAN SPEED**

This screen displays min and max exhaust fan speed percentages.

The speed setpoint is the proportional percentage of the analog output from the controller to the VFD.

25% Speed = Min speed

100% Speed = Max speed

**Setpoint Selections:**

**Constant Volume** – The fan speed will be constant; set from screen (e.g. 100%).

**BMS** – The BMS can directly control the fan speed (requires BMS communication option).

**Space Pressure** – Fan speed is determined by building pressure control loop.

**Supply Fan Tracking with Offset** – The exhaust fan will track the supply fan, between a min and max position. An offset can be added to achieve the proper balance.

**Outside Air Damper Tracking** – The exhaust fan will proportionally track the OA damper, between a min and max position.

**Return Duct Static Pressure** – Fan speed is determined by duct pressure control loop.

**0-10V Hardwired** - The 0-10V signal hardwired at the controller determines the speed of the fan after the controller sends an enable command to the vfd. When the signal is below the minimum fan speed setpoint, the fan will operate at minimum. When the signal is above the maximum fan speed setpoint, the fan will operate at maximum.

The **Occupancy** menu allows the user to adjust occupancy control parameters which includes occupancy control mode and schedule.

**OCCUPANCY CONTROL**

This screen displays the current mode of operation for occupancy control. Status of the other mode option can also be found on this screen. This screen allows the user to select the source of determining occupancy. The factory default is BMS control.

**BMS:** BMS front end sends an occupancy enable/disable to the controller via a selected protocol. (Reference Points List).

**Digital Input:** Typically used with a remote time clock, motion sensor or switch.

**Always Occ:** Controller will always remain occupied.

**Always Unocc:** Controller will always remain unoccupied.

**Schedule:** Allows the user to set an occupancy schedule for each individual day of the week.

**Override:** Informs the user that the unit is overridden to occupied from an external source. When DI Ovr Act, is displayed, the digital input for occupancy is being used as an override and is active. When TOV Active is displayed, the timed override feature has been activated at the space thermostat.

## Menu

```
Occupancy Schedule
Day: Friday
Schedule
Start Time: 06:00 AM
Stop Time: 06:00 PM
Currently: Occupied
```

```
Space T-Stat Occupancy
Timed Override
Duration: 60m
Status: Unoccupied
Time Remaining: 0m
```

```
Occupied Auto Mode
Enable: Disabled
Deadband: 4.0°F
Allows the unit to run
in Auto vs continuous.
Space reset must be
enabled.
```

```
Unoccupied Sequences
Cooling: Disabled
Heating: Disabled
Dehum: Disabled
Unoccupied starts
with enabled sequences
```

### Control Variables

↳ Advanced

```
User Login
Enter Password: 9998
Current Access:
Service Level
```

### Control Variables

↳ Advanced  
↳ Manual Overrides

```
IG Furnace Setup
Press ENTER to access
IG Furnace Commission
Unit must be running
```

```
Manual Unit Override
Overrides: Disabled
Duration: 720m
Time Remaining: 0:00
Status: Disabled
```

### **OCCUPANCY SCHEDULE**

This screen allows the user to adjust the schedule based on the day of the week. The user will select one of the following for each day of the week.

**Occupied:** Unit will be always occupied. (default when schedule is selected.)

**Unoccupied:** Unit will be always unoccupied.

**Schedule:** Requires the user to enter a start time, stop time and the applicable days of the schedule.

### **OCCUPANCY OVERRIDE - T-STAT ENABLED**

Screen allows the user to override occupancy for a set duration. This feature is then triggered by the factory-provided space thermostat occupancy button. Please see Appendix C for further information.

### **OCCUPIED AUTO MODE**

This screen allows the unit to operate in auto mode instead of continuous when occupied. An occupied start when in auto mode requires the unit start for a minimum of two minutes.

**Cooling:** The unit is enabled when the space temperature is greater than or equal to the cooling setpoint plus half of the deadband. The unit disables when the space temperature is less than the cooling setpoint.

**Heating:** The unit is enabled when the space temperature is less than or equal to the heating setpoint minus half of the deadband. The unit disables when the space temperature is greater than the heating setpoint.

### **UNOCCUPIED START ENABLE MODES**

*This screen only appears if unit is provided with unoccupied recirculation.*

This screen allows the user to enable/disable modes of operation when in unoccupied recirculation control.

The **Advanced** menu allows the user to access several submenus regarding controller information, controller overrides, network settings, I/O configuration, and unit configuration. Submenu options are read only and will require the user to input proper login criteria. The **service password (9998)** is required to change service access menus. Consult factory for factory level access.

The Manual Overrides menus are for start-up, commissioning, and troubleshooting.

### **IG FURNACE COMMISSIONING MENU**

This screen only appears if an indirect gas furnace was provided with the unit. Entering the furnace commissioning menu will step the user through the furnace start-up.

### **MANUAL OVERRIDE MODE**

The Manual Overrides menu is for start-up, commissioning, and troubleshooting. This menu allows the user to override the control loops and specific inputs and outputs.

To access the Manual Overrides submenus, enter the **service password (9998)**. Manual overrides must be enabled at this screen to allow the user to override control loops. Override options must be changed from Auto to Manual for manual control.

## Menu

### Unit On Off

Override: Auto  
Value: On

enable Main Override

### **VERRIDE UNIT ON OFF**

When manual override is set to enable, use the arrow buttons to turn the unit on or off.

### Occupancy

Override: Auto  
Value: Occupied

enable Main Override

### **VERRIDE OCCUPANCY CONTROL**

When manual override is set to enable, use the arrow buttons to change occupancy control.

### Outside Damper

Override: Auto  
Position: 35%

enable Main Override

### **VERRIDE OUTSIDE AIR DAMPER POSITION**

This screen only appears if the unit is equipped with a modulating OA damper. The recirculation damper position, if equipped, will be the inverse of the OA damper position shown.

0% = Outside air damper closed

100% = Outside air damper fully open

### Supply Fan

Override: Auto  
Command: On  
Speed: 100%

enable Main Override

### **VERRIDE SUPPLY FAN SPEED**

The speed is the proportional percentage of the analog output from the controller to the VFD.

0% Speed = Min speed (determined by VFD)

100% Speed = Max speed (determined by VFD)

### Exhaust Fan

Override: Auto  
Command: On  
Speed: 100%

enable Main Override

### **VERRIDE EXHAUST FAN SPEED**

This screen only appears if the unit is equipped with a exhaust fan VFD controlled by the microprocessor.

The speed is the proportional percentage of the analog output from the controller to the VFD.

0% Speed = Min speed (determined by VFD)

100% Speed = Max speed (determined by VFD)

### Compressor Request

Override: Auto  
1: Off 2: Off

enable Main Override

### **VERRIDE COMPRESSORS**

This screen only appears if the unit is equipped with DX cooling. When manual override is set to enable, use the arrow buttons to turn individual compressor requests on or off.

### Compressor Signal

Override: Auto  
1: 0%

enable Main Override

### **VERRIDE MODULATING COMPRESSOR SIGNAL**

When manual override is set to enable, use the arrow buttons to change the modulating compressor speed.

### Cooling Ramp 1

Override: Auto  
Demand: 0%

enable Main Override

### **VERRIDE COOLING**

When the cooling control is in the manual mode, use the arrow buttons to vary the cooling output.

**Chilled Water:** The cooling percent is directly proportional to the 0 - 10 VDC output signal.

0% Cooling = 0 VDC | 100% Cooling = 10 VDC

**Packaged Cooling:** The cooling percent displays compressor engagement as a percent. The compressors are subject to the min on/off times and heating/cooling lockouts.

```

Hot Gas Reheat Ramp
Override: Auto
Value: 100%
enable Main Override
    
```

### **OVERRIDE HOT GAS REHEAT**

This screen only appears if modulating hot gas reheat option was provided with the unit. When the hot gas reheat loop control is in the manual mode, use the arrow buttons to vary the reheat output.

```

Furnace Request
Override: Auto
F1S1: Off
F2S1: Off
    
```

### **OVERRIDE FURNACE**

One of these screens will appear to override indirect gas furnaces. The screen that appears is dependent on the furnace installed in the unit. Use the arrow buttons to turn on individual furnaces.

```

Furnace Request
Override: Auto
F1: Sm: Off Lg: Off
F2: Sm: Off Lg: Off
    
```

```

Furnace Signal
Override: Auto
Furnace 1: 0%
    
```

### **OVERRIDE FURNACE SIGNAL**

This screen appears to override the furnace signal from the controller. Use the arrow buttons to increase or decrease the capacity of the modulating furnace.

```

Electric Heat
Override: Auto
Elec Heater 1: 100%
enable Main Override
    
```

### **OVERRIDE ELECTRIC HEAT**

This screen only appears if the unit is equipped with electric post heat. Electric heater percentage is directly proportional to the 0 – 10 VDC output signal.

```

Heating Ramp
Override: Auto
Demand: 100%
enable Main Override
    
```

### **OVERRIDE HEATING**

When the heating control is in the manual mode, use the arrow buttons to vary the heating output.

```

Heat Pump Heating Ramp
Override: Auto
Demand: 0%
enable Main Override
    
```

### **OVERRIDE HEAT PUMP HEATING**

This screen will be available when the unit is configured as a heat pump. When in manual mode, change the demand to control the position of the reversing valve and the amount of compressor request. The compressors are subject to the min on/off times and heating lockouts.

```

Economizer Ramp
Override: Auto
Value: 0%
enable Main Override
    
```

### **OVERRIDE ECONOMIZER CONTROL**

When the heating control is in the manual mode, use the arrow buttons to vary the output of the economizer ramp. This value may have an effect on the energy recovery device and/or the modulating outside air damper position.

```

Preheat
Override: Auto
Enable: NO
    
```

### **OVERRIDE PREHEAT**

This screen appears when a preheater is installed in the unit for energy recovery defrost. Use the arrow buttons to override the preheat.

```

Defrost Ramp
Override: Auto
Value: 0%
-----
Reduces Energy Recovery
100%=Full Bypass/MinSpeed
ER Ramp: 100%
Enable Main Override
    
```

```

Energy Recovery Ramp
Override: Auto
Value: 0%
Actual output after
defrost: 0%
100%=Full Speed
    
```

```

Pressure Control
Compressor must be off
Override: Auto
-----
Ramp 1 Speed: 0.0%
Fixed Stages
Stg 2: Off
Enable Main Override
    
```

## Control Variables

- ↳ Advanced
- ↳ Advanced Setpoints

```

Advanced Setpoints
Occupied Dehum Call
-----
Enabled when:
OAT > Coil Set+Offset
    
```

```

Advanced Setpoints
Unoccupied Dehum Call
-----
Enabled when:
Indoor RH
    
```

```

Advanced Setpoints
Unocc Unit Operation
-----
Mode:
Night Setback Cycle
    
```

```

Advanced Setpoints
Morning Sequences
-----
Warm Up Enable: No
Cool Down Enable: No
Max duration: 30m
    
```

## Control Variables

- ↳ Advanced
- ↳ Network Settings

```

PCO Board Address
Enable DHCP: Disabled
IP: 10.52.20.8
Mask: 255.255.252.0
GW: 10.52.20.1
DNS: 10.52.1.22
-----
Save Changes: No
    
```

### **VERRIDE ENERGY RECOVERY DEFROST**

This screen only appears if modulating wheel frost control is equipped. When the defrost control ramp is in manual mode, use the arrow buttons to vary the defrost output.

0% = Maximum Wheel Speed | 100% = Minimum Wheel Speed

### **VERRIDE ENERGY RECOVERY**

This screen appears whenever an energy recovery device is installed. Use the arrow buttons when Manual Override is enabled to override the speed or position of the energy recovery device.

### **VERRIDE PRESSURE CONTROL FANS**

This screen will be available when active head pressure control is installed in the unit. When in manual mode, with the compressors off, the modulating fan speed can be altered by using the arrows to change the output. The fixed stage fan can be enabled by changing the output to On.

The Advanced Setpoints Menus allows the user to view and modify network settings. The **service password (9998)** is required to make changes.

### **CCUPIED DEHUMIDIFICATION CALL**

Reference control variables for possible Occupied dehumidification call methods.

### **UNOCCUPIED DEHUMIDIFICATION CALL**

Reference control variables for possible unoccupied dehumidification call methods.

### **UNOCCUPIED UNIT OPERATION**

Possible unoccupied unit operation methods include:

- Unit Off
- Night Setback Cycle
- Recirculation with Unoccupied Setpoints
- Normal Operation with Unoccupied Setpoints

### **MORNING WARM UP AND COOL DOWN**

This screen will appear when the unit has a recirculating air damper installed.

The user can enable morning warm up, morning cool down, and set the duration for the sequence.

The Network Settings Menus allows the user to view and modify network settings. The **service password (9998)** is required to make changes.

### **C.PCO BOARD ADDRESS**

This screen will appear with or without a network protocol provided with the unit.

This screen allows the user to configure the IP setting for BMS and/or when the Web User Interface will be utilized. The controller may have a DHCP server-assigned address or a manually assigned static IP address. Factory settings are shown in the screen to the left.

```

BACnet IP Config
Device:      0077077
Port:       0047808
    
```

### **BACNET IP CONFIG**

This screen will appear if the unit is set for BACnet IP and allows the user to set the device and port settings.

```

Modbus TCP Slave
Device ID:   1
    
```

### **MODBUS TCP SLAVE**

This screen will appear if the unit is set for Modbus TCP and allows the user to set device ID number.

```

BACnet MSTP Config
Device:      0077077
Info Frames: 20
Max Masters: 127
Mstp Address: 77
Baud Rate:   76800
Save Settings: No
    
```

### **BACNET MSTP PARAMETERS**

This screen only appears if the selected BMS protocol is set to BACnet MSTP. Factory settings are shown in the screen to the left.

#### **To change BACnet MSTP parameters:**

1. Go to Network Settings menu and view BACnet MSTP Config screen.
2. Move cursor to desired parameter by pressing the enter button. Press up and down arrows to adjust the parameter. Press enter to accept adjusted value.
3. Once desired parameters have been entered, enable the 'Save Settings' option and press the enter button.
4. Reboot the controller by cycling power to the unit or holding the main menu/target button for 3 seconds to stop the unit operation and restart the controller.

```

Modbus RTU Config
Device ID:   1
Baud Rate:   38400
Stop Bits:   2
Parity:      none
Save Settings: No
    
```

### **MODBUS RTU PARAMETERS**

This screen only appears if the selected BMS protocol is set to Modbus. Factory settings are shown in the screen to the left.

#### **To change Modbus RTU parameters:**

1. Go to Network Settings menu and view Modbus RTU Config screen.
2. Move cursor to desired parameter by pressing the enter button. Press up and down arrows to adjust the parameter. Press enter to accept adjusted value.
3. Once desired parameters have been entered, enable the 'Save Settings' option and press the enter button.
4. Reboot the controller by cycling power to the unit or holding the main menu/target button for 3 seconds to stop the unit operation and restart the controller.

```

BMS Watchdog
Enable:      No
Timeout Delay: 15m
Status:      Active
Write 1 to BACnet BU-1
within timeout delay
to command values.
    
```

### **BMS WATCHDOG**

The BMS watchdog function verifies BMS connectivity. The watchdog is required for the BMS to take the place of a hardwired sensor. The BMS toggles the watchdog variable from true to false within the timeout delay. If the timer expires, the controller falls back to hardwired sensors until the BMS connection can be established. At this time, a BMS watchdog alarm activates.

The following variables may be used by the BMS in place of hardwired sensors:

- Outside\_RH\_from\_BMS
- Outside\_Temp\_from\_BMS
- Return\_RH\_from\_BMS
- Return\_Temp\_from\_BMS
- Space\_1\_CO2\_from\_BMS
- Return\_CO2\_from\_BMS
- Space\_RH\_from\_BMS
- Space\_Static\_from\_BMS
- Space\_Temp\_from\_BMS



## **SENSOR SOURCE**

The sensor source can be changed to source by BMS through the controller or by a dedicated BMS point. Reference Points List and in the Appendix for more detailed point information. The screen to the left is an example of the sensor source type. Source can be set for local or BMS at this screen.

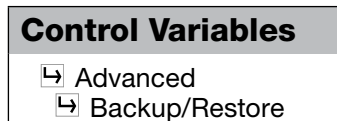

The Backup/Restore Menus allows the user to create a backup file of setpoints and configuration variables on a USB drive or in the controller's internal memory.



## **Connecting to USB Drives**

The controller has built-in USB ports for connecting to USB drives. or to the USB port of a computer. This allows the user to perform various operations including upgrading an application or OS, saving or retrieving logs, user backups, and viewing the web user interface.

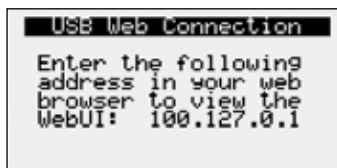

Connecting a USB cable to a computer shows a screen on the controller that allows the user to choose whether to access files (disk drive) or the WebUI by using the arrow buttons.

The controller will either have a USB Type A, USB Type B or Micro USB dependent on model.

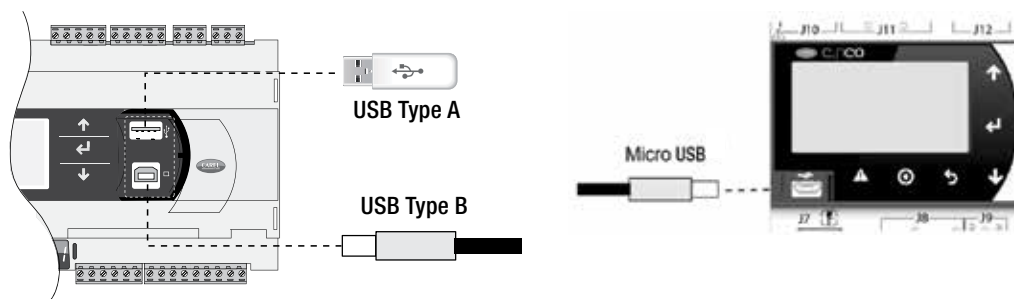

## **CREATING A BACKUP FILE**

Important:

- At first startup or commissioning, or prior to communicating with Technical Support about performance issues, we recommend creating a backup file for each controller.
- Name each file with the unit sales order–line number found on the silver nameplate attached to the electrical access door.
- Also consider creating a backup file whenever significant program changes are made.

To create a system backup file using the handheld or virtual keypad/display buttons:

1. Go to the Main Menu/Ctrl Variables/Advanced/Login screen. Press the Enter and Up or Down arrow buttons to enter the service password, which is 9998.
2. Go to the Main Menu/Ctrl Variables/Advanced/Backup/Restore screen.
3. Press the Up or Down arrow buttons to navigate to the Backup Settings screen.
4. Press the Enter and Up or Down arrow buttons to select the backup location (internal memory or USB). If creating a backup to a USB drive, insert a USB drive into the main controller.
5. Press Enter to highlight and then the Up or Down arrow buttons to fill the Save checkbox. This action creates the backup file.

## Menu



### **RESTORING FROM A BACKUP FILE**

#### **From USB**

1. Place the restore file in the root directory of a USB drive. (Do not place the file within a folder on the USB drive.) The file must be named: User\_Backup.txt
2. Insert the USB drive into the controller's USB port.
3. Go to the Main Menu/Unit Enable screen. Press the Enter and Up or Down arrow buttons to disable the unit.
4. Go to the Main Menu/Ctrl Variables/Advanced/Login screen. Press the Enter and Up or Down arrow buttons to enter the service password (9998).
5. Go to the Main Menu/Ctrl Variables/Advanced/Backup/Restore screen.
6. Press the Up or Down arrow buttons to navigate to the USB Restore screen.
7. Press Enter to highlight and then the Up or Down arrow buttons to fill the Restore checkbox. This action restores the backup file. If there is an error during the process, the specific error is displayed on this screen.
8. Controller will automatically restart.

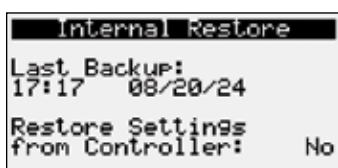

#### **From internal memory**

1. Go to the Main Menu/Unit Enable screen. Press the Enter and Up or Down arrow buttons to disable the unit.
2. Go to the Main Menu/Ctrl Variables/Advanced/Login screen. Press the Enter and Up or Down arrow buttons to enter the service password, which is 9998.
3. Go to the Main Menu/Ctrl Variables/Advanced/Backup/Restore screen.
4. Press the Up or Down arrow buttons to navigate to the Internal Restore screen. This screen is only available when a backup file exists in internal memory.
5. Press Enter to highlight and then the Up or Down arrow buttons to fill the Restore checkbox. This action restores the backup file. If there is an error during the process, the specific error is displayed on this screen.
6. Controller will automatically restart.

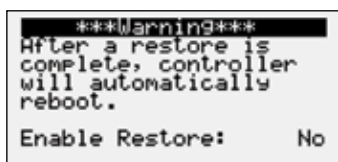

### **Control Variables**

- ↳ Advanced
- ↳ I/O Configuration

The **IO Configuration Menu** allows the user to view and modify controller input and output points.

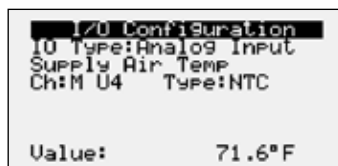

### **I/O CONFIGURATION**

This screen is read only and will require the factory password to make changes. The screen to the left is an example of an analog input configuration screen. Similar screens appear for remaining I/O when selected.

#### **To monitor individual I/O points:**

1. Press the enter button to highlight the I/O type.
2. Press the up and down arrows to change the IO type.
3. Press the enter button to highlight the controller channel.
4. Press the up and down arrows to change the channel.



### **I/O CONFIGURATION OPTIONS**

Changes to the IO configuration requires the factory login password. Consult factory for IO configuration changes.

**ADJUSTMENT OF I/O CONFIGURATION MUST ONLY BE DONE UNDER FACTORY GUIDANCE! IMPROPER ADJUSTMENT MAY RESULT IN SYSTEM DAMAGE!**

### **Control Variables**

- ↳ Advanced
- ↳ Unit Config
- ↳ Service Config

The **Unit Configuration** menus allows the user to view the unit configuration provided from factory. Configuration menus listed below can be altered with the service password. Consult factory for unit configuration changes!

## Menu

```
Service Unit Config
Supply Fan Control
Type: Constant Volume
K Factor: 0.0
```

```
Service Unit Config
Exhaust Fan Control
Type: Space Static
K Factor: 0.0
```

### **SUPPLY FAN CONTROL**

Please reference the supply fan sequence section for possible control methods.

### **EXHAUST FAN CONTROL**

Please reference the exhaust fan sequence section for possible control methods.

## Alarms

The **Alarms** menu allows the user to view active alarms, reset active alarms and view, clear or export the alarm history.

```
Active Alarms 0/0
No Active Alarms
ENTER → Alarm History
ALARM → Alarm Reset
```

### **ACTIVE ALARMS**

If an alarm occurs, the button will glow red on the controller and the remote display (if installed).

To view alarm, press the Alarm button once. This will display the most recent alarm. If the alarm cannot be cleared, the cause of the alarm has not been fixed. Press the up and down buttons to view any additional occurring alarms.

```
Reset Active Alarms
Press ENTER to reset
active alarms.
Alarm Count: 00
```

### **RESET ACTIVE ALARMS**

This screen allows the user to clear active alarms.

```
Alarm Event History
Record: 001++ 10:044
Exp Board 4 Status
Board is Offline
Alarmed: 09:45am 01/24
```

### **ALARM EVENT HISTORY**

This screen allows the user view recent alarms. To view all saved alarms, press the “down” button to enter the data logger.

```
Clear Alarm Log
Clear Alarm Log? No
```

### **CLEAR ALARM LOG**

This screen allows the user to clear all alarms in alarm log history.

## Appendix A: Remote Display (pGD1)

The pGD1 is an optional remote display for use with manufacturer's microprocessor controllers. The remote display allows for remote monitoring and adjustment of parameters of the unit mounted controller. The remote display allows identical access to menus and screens as the unit mounted controller display. If the controller is the c.pCOMini model, the remote display is not available when the unit has BACnet MSTP or Modbus RTU.



<b>Specifications</b>	
Carel Model	PGD1000W00
Power Supply	Power supplied from unit controller through RJ25 cable
Max distance from unit controller	150 feet
Required Cable	6P6C RJ25/RJ12 Cable (straight)
Operating Conditions	-4°F to 140°F, 90%RH (non-condensing)
Display Type	Backlit LED with lighted buttons

### Installation

The remote display connects to the unit mounted controller through a six-wire RJ25 or RJ12 telephone cable (straight). When ordered from the factory, a 10 ft. cable is provided with the remote display. The display and cable can be used to assist with start-up and maintenance.

### Connecting Cable

If mounted remotely, the factory cable can either be extended or replaced with a longer cable up to the listed maximum distance. The resulting cable connections should be a "straight through cable," where pins on one end correspond identically to the pins on the opposite end. If making your own cable, use the same pin-out for each end.

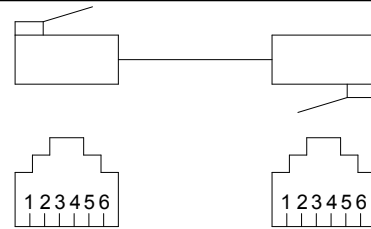

**c.pCO Controller Remote Display Connection**

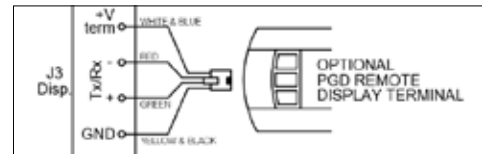

**c.pCOMini Controller Remote Display Connection**

## Appendix B: I/O Expansion Board (c.pCOe) Quick Start

The expansion board is an I/O module that can be used to monitor additional statuses or provide commands from large board controller. It allows the user to view and control:

- 6 Universal Inputs (Digital Input\*, NTC, 0/1VDC, 0/10VDC, 0/20mA, 4/20mA, 0/5VDC)  
\*Only dry to ground contacts can be utilized for digital inputs. Applying voltage will result in damage to the I/O expansion board.
- 4 Analog Outputs (VDC)
- 6 Digital Outputs

The inputs and outputs can be monitored and controlled by the Building Management System. Reference Points List for detailed point information.

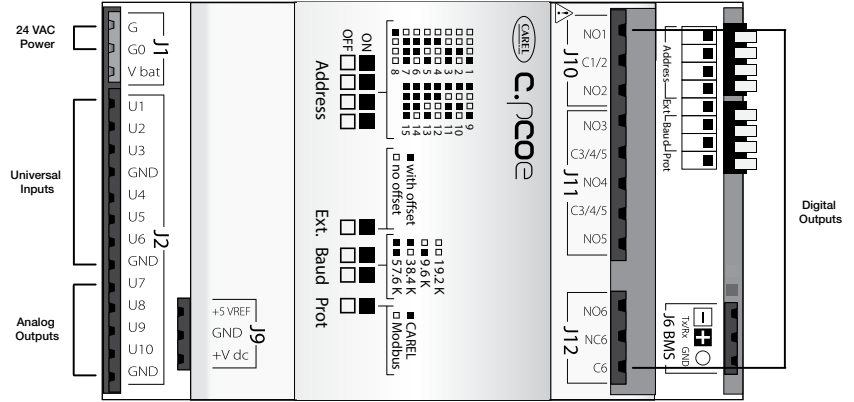

### Setup

In order for the controller to communicate with the c.pCOe, several parameters must be adjusted. If you have a c.pCOe installed from the factory, the controller is already set up for communication with the main controller. The factory password is required for expansion board and I/O configuration updates. Consult factory for I/O configuration changes.

```

Expansion Boards
1: c.pCOe - Address+02
2: Not Installed
3: c.pCOe - Address+04
4: Not Installed
5: Not Installed
6: Not Installed
**Reboot Controller**
    
```

```

Service Unit Config
Aux IO - Monitor Only
Aux IO: Not Installed
    
```

```

I/O Config Options
Edit IO: Disabled
Devices Shown: Config
Enable to edit IO.
Scroll by configured
or all devices.
    
```

```

I/O Configuration
IO Type: Analog Input
Aux In Customer 5
Ch: E4 U5 Type: 0-10U
Min: 0.0°F
Max: 100.0°F
Value: 32.0°F
    
```

```

AUX I/O Config
Aux In Customer 5
Ch: E4 U5 UM: °F
Type: 0-10U
Min: 0.0°F
Max: 100.0°F
Value: 32.0°F
    
```

**Enable the c.pCOe for Auxiliary I/O-** To enable the c.pCOe expansion I/O module, go to Ctrl Variables/Advanced/Unit Config/Service Config. User will have to enter the Service Password to make any edits at this point. Consult factory for help configuring the expansion board. The expansion board must be enabled to configure spare I/O points. Once enabled, the user must reboot the controller. See screens to the left for expansion board enable points.

**Aux IO Installed-** Checking the Aux IO Installed check box allows the Aux IO Config menu to show in the Control Variables menu. This is a shortcut to access the auxiliary I/O after it is configured in the I/O Configuration menu.

**Configuring the I/O Type -** In order to edit and configure the I/O configuration of the unit, go to Ctrl Variables/Advanced/I/O Configuration. The user must enable the Editable option for configuring I/O points. If configuring a new I/O point, 'Scroll by All Configured' must be deselected to view all I/O options.

**Change or Update the I/O Point -** Once the editable option is selected, the user must scroll to the I/O Configuration Menu. At this menu the desired I/O type can be selected. Once selected the user can configure the desired channel at the expansion board. The channel will have an 'E' designation for expansion board. Aux In Customer 1-6, Aux Analog Out 1, and Aux Digital Out 1-2 will be allocated for the I/O expansion board.

**Viewing c.pCOe Auxiliary Values -** Once the expansion board I/O is configured, the user can view and/or change the I/O type by navigating to Ctrl Variables/Aux I/O Config.

## Appendix C: Space Thermostat Quick Start



The space thermostat gives users the ability to view the space temperature and relative humidity (optional) and control the active space setpoints from the adjustable display. The space thermostat also has the ability to send the unit into temporary occupied mode. Up to four space thermostats can be wired back to the microprocessor to provide an average for the space temperature and humidity (optional). The space thermostat is shipped loose with installation by others and is a Modbus connected device.

Space thermostat functions:

- Temporary occupancy override control
- Temperature and relative humidity monitoring
- Temperature and relative humidity setpoint adjustability
- Status icon on LCD display with push buttons

### Display

If more than one space thermostat is provided for averaging, only one space thermostat will be provided with a display and push buttons for adjustment.

**Adjusting Setpoint** - The default display will show the current temperature value for the room. Use the scroll button to index through additional sensor parameters. Parameters with the "SETPOINT" icon displayed above the temperature display are adjustable. Use the Up/Down buttons to adjust the setpoint, and use the scroll button to view the next parameter or return to the normal display mode.

**Up/Down Button Function** - The Up/Down buttons are used to adjust editable parameters including the temperature and humidity setpoint.

**Override Button Function** - The display shows a person in the lower left corner of the display at all times. If the person is solid, the unit is operating in occupied mode. If it is an outline of the person, the unit is in unoccupied mode. Pushing the Override button when the unit is in unoccupied mode temporarily overrides the sequence to Occupied mode for a period of 1 to 4 hours (adjustable at the unit microprocessor).

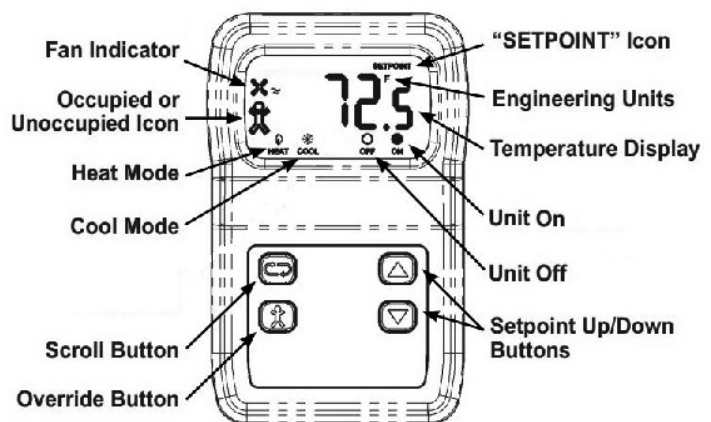

### Initial Setup and Communication Configuration

The space thermostat is a Modbus connected device. Up to three additional Modbus sensors can be added for space temperature or space temperature and humidity averaging. The sensors must all be connected in a daisy chain configuration.

If space temperature averaging is desired, additional field setup may be required both in the controller and on the Modbus space sensors:

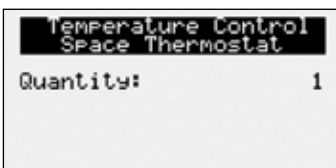

- Each space sensor must have the DIP switches adjusted on the back of the sensor to the corresponding switches. Reference Space Thermostat Modbus Address chart on the following page for DIP switches settings.
- Once the address is set and the wires are connected the "Status" LED should be a steady green and the "Network" LED should be a quick blinking amber/green color.
- To add additional sensors in the field, enter the Ctrl Variables Menu/Temperature and scroll down in the Temperature Menu to select Space Thermostat. Choose the number of space sensor being used (1-4).

## Appendix C: Space Thermostat Quick Start

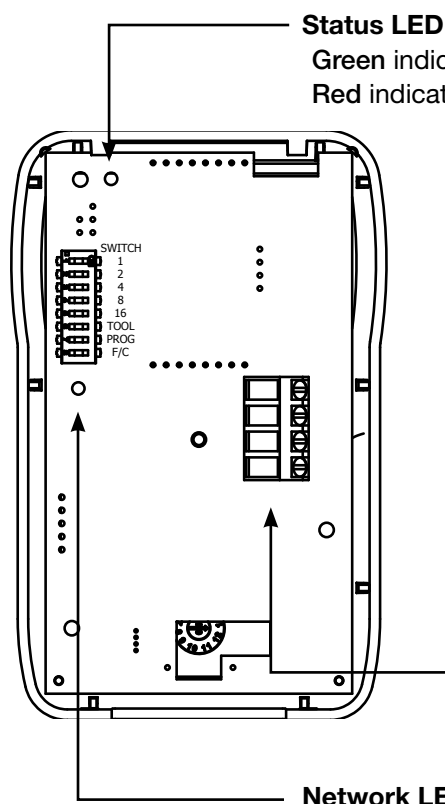

**Status LED**  
 Green indicates that the unit is operating properly.  
 Red indicates that there is a problem with the unit.

Terminal	Description
GND	Power Supply Ground (common to the controller)
Net B	RS485 network connection (Data -)
Net A	RS485 network connection (Data +)
Power	Power supply hot

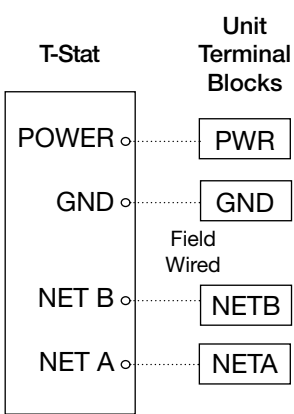

**Network LED**  
**Flashing Red Slowly** - Indicates that there has been no communications for 60 seconds.  
**Flashing Green Slowly** - Indicates that there have been normal communications within the last 60 seconds.  
**Flashing Green Slowly with Quick Red Flashes** - The quick red flashes indicate active communications.

Space Thermostat Modbus Address				
	T-Stat 1 (Display)	T-Stat 2	T-Stat 3	T-Stat 4
Address in Microprocessor	10	11	12	13
Dip Switch Set on Stat	Sw 2 + Sw 8	Sw 1 + Sw 2 + Sw 8	Sw 4 + Sw 8	Sw 1 + Sw 4 + Sw 8

### Baud Rate Setting

In order for the space thermostat to communicate with the microprocessor, the correct baud rate must be set in the space thermostat. To set the baud rate:

- The “PROG” DIP switch on the back of the space thermostat must be flipped to the right side.
- Use the Setpoint Down button to display P11 on the space thermostat.
- Push the Scroll button and use the Setpoint Up/Down buttons to adjust the baud rate to 192.
- Once 192 is displayed, push the Scroll button again to save the setting. Once the setting is saved, P11 should appear on the display.
- Flip the “PROG” DIP switch on the back of the space thermostat back to the left. The space thermostat should communicate and be set back to normal mode.

## Appendix D: GreenTrol® Airflow Monitoring Quick Start

```
Airflow Status
Supply Fan:  0 cfm
Exhaust Fan: 0 cfm
Outside Air: 0 cfm
```

The GreenTrol® airflow monitoring station measures airflow using advanced thermal dispersion technology. An integral LCD display provides a local indication of airflow measurement and device configuration. The airflow monitor also features Modbus communication allowing the microprocessor to monitor the airflow as well. The GreenTrol also accepts up to two airflow probes for averaging.

GreenTrol Airflow Monitor functions:

- LCD readout of measured airflow
- Dual airflow probe averaging
- Modbus connectivity



### Display and Navigation

The LCD screen shows the current airflow that is being measured. To enter the menu to set up the monitoring station, the user must remove the front cover of the GreenTrol to uncover the navigation buttons. Press and hold the UP and DOWN buttons at the same time for 3 seconds to enter the menu.

**Enter Button Function** - The ENTER button allows the user to go into the selected menu or function and save the selected value.

**Up/Down Button Function** - The Up/Down buttons are used to navigate the menu and to change values in the menu.

**Esc Button Function** - The ESC button allows the user to exit the current menu or function.

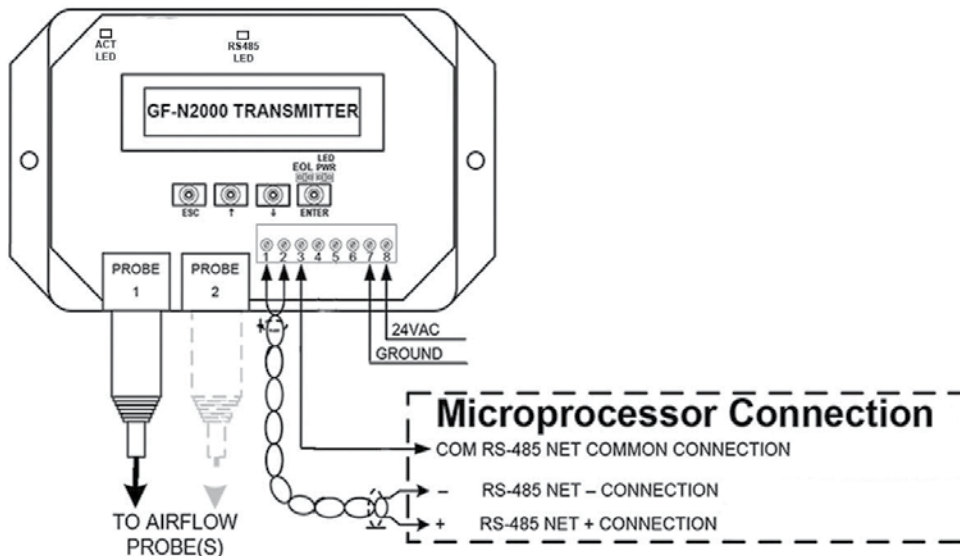

## Appendix E: Points List

Variable	Description	BACnet	Modbus	Read Write	Text or Unit of M	
		Object	Register		Active	Inactive
Space_Temp_Analog_Input	Space Temperature	AI-1*	30002	R		°F
Supply_Temp_Analog_Input	Supply Temperature	AI-2*	30004	R		°F
Outside_Air_Temp_Analog_Input	Outside Air Temperature	AI-3*	30006	R		°F
Mixed_Temp_Analog_Input	Mixed Temperature	AI-4*	30008	R		°F
Cold_Coil_1_Temp_Analog_Input	Cold Coil 1 Temperature	AI-5*	30010	R		°F
Return_Temp_Analog_Input	Return Temperature	AI-7*	30014	R		°F
Exhaust_Temp_Analog_Input	Exhaust Temperature	AI-8*	30016	R		°F
Space_RH_Analog_Input	Space % Relative Humidity	AI-9*	30018	R		%
Outside_RH_Analog_Input	Outside % Relative Humidity	AI-10*	30020	R		%
Return_RH_Analog_Input	Return % Relative Humidity	AI-11*	30022	R		%
Return_Duct_Static_Pressure_Analog_Input	Return Duct Static Pressure	AI-12*	30024	R		"wc
Space_Static_Pressure_Analog_Input	Space Static Pressure	AI-13*	30026	R		"wc
Supply_Duct_Static_Pressure_Analog_Input	Supply Duct Static Pressure	AI-14*	30028	R		"wc
Space_CO2_1_Analog_Input	Space 1 CO2 ppm	AI-15*	30030	R		ppm
Space_CO2_2_Analog_Input	Space 2 CO2 ppm	AI-16	30032	R		ppm
Return_CO2_Analog_Input	Return CO2 ppm	AI-17*	30034	R		ppm
CL_Coil_Spt_Temp	HeatCool Only - Cooling Coil Setpoint Input	AI-18*	30036	R		2-10V = 50-75°F
CL_Supply_Spt_Temp	HeatCool Only - Supply Setpoint Temperature	AI-19*	30038	R		2-10V = 50-95°F
Circuit_A_Discharge_Temp_Analog_Input	Circuit A Discharge Temperature	AI-20	30040	R		°F
Circuit_A_Suction_Temp_Analog_Input	Circuit A Suction Temperature	AI-21	30042	R		°F
Circuit_B_Discharge_Temp_Analog_Input	Circuit B Discharge Temperature	AI-22	30044	R		°F
Circuit_B_Suction_Temp_Analog_Input	Circuit B Suction Temperature	AI-23	30046	R		°F
Circuit_A_Discharge_Pressure_Analog_Input	Circuit A Discharge Pressure	AI-28	30056	R		psig
Circuit_A_Suction_Pressure_Analog_Input	Circuit A Suction Pressure	AI-29	30058	R		psig
Circuit_B_Discharge_Pressure_Analog_Input	Circuit B Discharge Pressure	AI-30	30060	R		psig
Circuit_B_Suction_Pressure_Analog_Input	Circuit B Suction Pressure	AI-31	30062	R		psig

## Appendix E: Points List

Variable	Description	BACnet	Modbus	Read Write	Text or Unit of M	
		Object	Register		Active	Inactive
Aux_In_Customer_1	Customer defined auxiliary input	AI-36*	30072	R	selectable	
Aux_In_Customer_2	Customer defined auxiliary input	AI-37*	30074	R	selectable	
Aux_In_Customer_3	Customer defined auxiliary input	AI-38*	30076	R	selectable	
Aux_In_Customer_4	Customer defined auxiliary input	AI-39*	30078	R	selectable	
Aux_In_Customer_5	Customer defined auxiliary input	AI-40*	30080	R	selectable	
Aux_In_Customer_6	Customer defined auxiliary input	AI-41*	30082	R	selectable	
Aux_In_Customer_7	Customer defined auxiliary input	AI-42	30084	R	selectable	
Aux_In_Customer_8	Customer defined auxiliary input	AI-43	30086	R	selectable	
Aux_In_Customer_9	Customer defined auxiliary input	AI-44	30088	R	selectable	
Aux_In_Customer_10	Customer defined auxiliary input	AI-45	30090	R	selectable	
Circuit_A_Liquid_Line_Temp_Analog_Input	Circuit A Liquid Line Temperature	AI-46	30256	R	°F	
Circuit_B_Liquid_Line_Temp_Analog_Input	Circuit B Liquid Line Temperature	AI-47	30258	R	°F	
Circuit_A_Liquid_Line_Pressure_Analog_Input	Circuit A Liquid Line Pressure	AI-48	30260	R	psig	
Circuit_B_Liquid_Line_Pressure_Analog_Input	Circuit B Liquid Line Pressure	AI-49	30262	R	psig	
Temperature_Setpoint	Temperature Setpoint used for Supply, Space, or Return temperature control	AV-1*	40002	RW	°F	
Temperature_Heat_Cool_Deadband	Heat/Cool Spt Deadband for Space or Return Reset	AV-2	40004	RW	Δ°F	
Temperature_Setpoint_Unoccupied	Temperature Setpoint used for Supply, Space, or Return temperature control	AV-3*	40006	RW	°F	
Temperature_Heat_Cool_Deadband_Unoccupied	Heat/Cool Spt Deadband for Space or Return Reset	AV-4	40008	RW	Δ°F	
Cooling_Coil_Setpoint_Min	Cooling Coil Leaving Air Setpoint	AV-5	40010	RW	°F	
Cooling_Coil_Setpoint_Max	Maximum Coil Leaving Setpoint	AV-6	40012	RW	°F	
Dehumidification_Setpoint	Dehumidification Setpoint %RH	AV-7	40014	RW	%	
Outside_Dewpoint_Setpoint	Outside Dewpoint Dehumidification Trigger	AV-8	40016	RW	°F	
Indoor_Dewpoint_Setpoint	Indoor Dewpoint Dehumidification Trigger	AV-9	40018	RW	°F	
Unocc_Indoor_Dewpoint_Setpoint	Unoccupied Indoor Dewpoint Dehumidification	AV-10	40020	RW	°F	
Unoccupied_Dehumidification_Setpoint	Unoccupied Dehumidification %RH Setpoint	AV-11	40022	RW	%	

## Appendix E: Points List

Variable	Description	BACnet	Modbus	Read Write	Text or Unit of M	
		Object	Register		Active	Inactive
Economizer_Temp_Enable_Setpoint	Economizer Ambient Temp Enable Setpoint Allow Econ when OAT< Setpoint	AV-12	40024	RW	°F	
Economizer_Enthalpy_Enable_Setpoint	Economizer Enthalpy Enable Setpoint Allow Econ when OA Enthalpy<Setpoint	AV-13	40026	RW	btu/lb	
Cooling_Lockout_Setpoint	Cooling Ambient Lockout Setpoint	AV-17*	40034	RW	°F	
Heating_Lockout_Setpoint	Heating Ambient Lockout Setpoint	AV-18*	40036	RW	°F	
Preheat_Lockout_Setpoint	Preheat Ambient Lockout Setpoint	AV-19*	40038	RW	°F	
Economizer_Lockout_Setpoint	Economizer Ambient Lockout Setpoint	AV-20	40040	RW	°F	
Return_Duct_Static_Pressure_Setpoint	Return Duct Static Pressure Setpoint	AV-21*	40042	RW	"wc	
Space_Static_Pressure_Setpoint	Space Static Pressure Setpoint	AV-22*	40044	RW	"wc	
Supply_Duct_Static_Pressure_Setpoint	Supply Duct Static Pressure Setpoint	AV-23*	40046	RW	"wc	
Space_CO2_Setpoint	Space CO2 Setpoint	AV-24*	40048	RW	ppm	
Outside_Air_Damper_Minimum_Setpoint_Occ	Outside Air Damper Minimum Setpoint	AV-25*	40050	RW	%	
Outside_RH_from_BMS	Outside RH from BMS	AV-26	40052	RW	%	
Outside_Temp_from_BMS	Outside Temp from BMS - source is BMS	AV-27	40054	RW	°F	
Return_RH_from_BMS	Return RH from BMS - source is BMS	AV-28	40056	RW	%	
Return_Temp_from_BMS	Return Temp from BMS - source is BMS	AV-29	40058	RW	°F	
Space_1_CO2_from_BMS	Space 1 CO2 from BMS - source is BMS	AV-30	40060	RW	ppm	
Space_2_CO2_from_BMS	Space 2 CO2 from BMS - source is BMS	AV-31	40062	RW	ppm	
Return_CO2_from_BMS	Return CO2 from BMS - source is BMS	AV-32	40064	RW	ppm	
Space_RH_from_BMS	Space RH from BMS - source is BMS	AV-33	40066	RW	%	
Space_Static_from_BMS	Space Static from BMS - source is BMS	AV-34	40068	RW	"wc	
Space_Temp_from_BMS	Space Temp from BMS - source is BMS	AV-35	40070	RW	°F	
SF_Control_Signal_BMS	BMS to control signal for supply fan speed	AV-36	40072	RW	%	
EF_Control_Signal_BMS	BMS to control signal for exhaust fan speed	AV-37	40074	RW	%	
OAD_Control_Signal_BMS	Allows the BMS to control OAD position	AV-38	40076	RW	%	
Aux_BMS_Analog_Output_1	BMS Commanded auxiliary analog output	AV-39*	40078	RW	selectable	

## Appendix E: Points List

Variable	Description	BACnet	Modbus	Read Write	Text or Unit of M	
		Object	Register		Active	Inactive
Unit_Status_Mode	Unit Status Mode - See Table	AV-40*	30092	R	Real	
Supply_Temperature_Calculated_Setpoint	Active Supply Temperature Setpoint	AV-41*	30094	R	°F	
Cooling_1_Ramp_Capacity	Cooling Ramp 1 Status Value	AV-42*	30096	R	%	
Defrost_Ramp	Defrost Ramp	AV-44	30100	R	%	
Economizer_Ramp	Economizer Ramp	AV-45	30102	R	%	
Head_Pressure_Control_Ramp_1_Ramp	Head Pressure Control Ramp 1	AV-46	30104	R	%	
Head_Pressure_Control_Ramp_2_Ramp	Head Pressure Control Ramp 2	AV-47	30106	R	%	
HP_Ramp_Capacity	Heat Pump Heating Ramp	AV-50*	30112	R	%	
Heating_Capacity	Heating Ramp	AV-51*	30114	R	%	
Case_Heat_Control_Ramp	Case Heat Ramp	AV-52*	30116	R	%	
Hot_Gas_Reheat_Ramp	Hot Gas Reheat Ramp	AV-53*	30118	R	%	
Outside_Dewpoint	Outside Dewpoint	AV-54	30120	R	°F	
Outside_Enthalpy	Outside Enthalpy	AV-55	30122	R	btu/lb	
Return_Dewpoint	Return Dewpoint	AV-56	30124	R	°F	
Return_Enthalpy	Return Enthalpy	AV-57	30126	R	btu/lb	
Space_Dewpoint	Space Dewpoint	AV-58	30128	R	°F	
Space_Enthalpy	Space Enthalpy	AV-59	30130	R	btu/lb	
Circuit_A_Superheat	Circuit A Superheat	AV-60	30132	R	°F	
Circuit_B_Superheat	Circuit B Superheat	AV-61	30134	R	°F	
Total_Exhaust_Fan_CFM_BMS	Total Exhaust Fan CFM	AV-64*	30140	R	cfm	
Total_Supply_Fan_CFM_BMS	Total Supply Fan CFM	AV-65*	30142	R	cfm	
OAD_CFM_BMS	OAD CFM	AV-66*	30144	R	cfm	
Active_Temperature_Setpoint	Active Temperature Setpoint	AV-67*	30146	R	°F	
Chilled_Water_1_Valve_Analog_Output	Chilled Water 1 Valve Analog Output	AV-68	30148	R	%	
Electric_Heater_1_Analog_Output	Electric Heater 1 Analog Output	AV-70	30152	R	%	

## Appendix E: Points List

Variable	Description	BACnet	Modbus	Read Write	Text or Unit of M	
		Object	Register		Active	Inactive
Energy_Recovery_Analog_Output	Energy Recovery Analog Output	AV-72*	30156	R	%	
Exhaust_Fan_Speed_Analog_Output	Exhaust Fan Speed Analog Output	AV-73*	30158	R	%	
Hot_Water_Valve_1_Analog_Output	Hot Water Valve 1 Analog Output	AV-74	30160	R	%	
Mod_Gas_Furnace_1_Analog_Output	Mod Gas Furnace 1 Analog Output	AV-76	30164	R	%	
Outside_Air_Damper_Analog_Output	Outside Air Damper Analog Output	AV-78*	30168	R	%	
Supply_Fan_Speed_Analog_Output	Supply Fan Speed Analog Output	AV-79*	30170	R	%	
Modulating_Compressor_Analog_Output_BMS	First Modulating Compressor Analog Output - BMS	AV-80	30172	R	%	
Circuit_A_Sat_Discharge_Temperature	Circuit A Saturated Discharge Temperature	AV-82	30176	R	°F	
Circuit_B_Sat_Discharge_Temperature	Circuit B Saturated Discharge Temperature	AV-83	30178	R	°F	
Circuit_A_Sat_Suction_Temperature	Circuit A Saturated Suction Temperature	AV-86	30184	R	°F	
Circuit_B_Sat_Suction_Temperature	Circuit B Saturated Suction Temperature	AV-87	30186	R	°F	
Coil_Temperature_Calculated_Setpoint	Calculated Coil Leaving Set point	AV-90*	30192	R	°F	
Active_Cooling_Setpoint	Active Cooling Setpoint	AV-91	30194	R	°F	
Active_Heating_Setpoint	Active Heating Setpoint	AV-92	30196	R	°F	
LatestAlm_AV	Most recent alarm - See Alarm Table	AV-93	30230	R	Integer	
Device_Enable_DO_Word_Real_1	Device Enable DO Word - See Table	AV-94	30232	R	Bit Pack	
Device_Enable_DO_Word_Real_2	Device Enable DO Word - See Table	AV-95	30234	R	Bit Pack	
Ref_Ckt_PressTemp_Alarm_Word_Real_1	Refrigeration Circuit Word - See Table	AV-96	30236	R	Bit Pack	
Ref_Ckt_PressTemp_Alarm_Word_Real_2	Refrigeration Circuit Word - See Table	AV-97	30238	R	Bit Pack	
Device_Offline_Word_Real_1	Device Offline Word - See Table	AV-98	30240	R	Bit Pack	
Device_Offline_Word_Real_2	Device Offline Word - See Table	AV-99	30242	R	Bit Pack	
Device_Alarm_Word_Real_1	Device Alarm Word - See Table	AV-100	30244	R	Bit Pack	
Device_Alarm_Word_Real_2	Device Alarm Word - See Table	AV-101	30246	R	Bit Pack	
System_Word_Real_1	System Word - See Table	AV-102	30248	R	Bit Pack	
System_Word_Real_2	System Word - See Table	AV-103	30250	R	Bit Pack	
Unit_Status_Word_Real_1	Unit Status Word - See Table	AV-104	30252	R	Bit Pack	

## Appendix E: Points List

Variable	Description	BACnet	Modbus	Read Write	Text or Unit of M	
		Object	Register		Active	Inactive
Unit_Status_Word_Real_2	Unit Status Word - See Table	AV-105	30254	R	Bit Pack	
Circuit_A_Subcool	Circuit A Subcooling	AV-106	30264	R	°F	
Circuit_B_Subcool	Circuit B Subcooling	AV-107	30266	R	°F	
Temperature_Reset_Mode	Occupied Reset Type Setpoint	IV-1*	40080	RW	1-Discharge, 2-Space 3-Return, 4-Outside	
Temperature_Reset_Mode_Unoccupied	Unoccupied Reset Type Setpoint	IV-2*	40082	RW	1-Discharge, 2-Space 3-Return	
Active_Temperature_Reset_Mode	Active Occupied Reset Type Setpoint	IV-3	30198	R	1-Discharge, 2-Space 3-Return, 4-Outside	
Active_Temperature_Reset_Mode_Unocc	Active Unoccupied Reset Type Setpoint	IV-4	30200	R	1-Discharge, 2-Space 3-Return	
LatestAlm	Most recent alarm - See Alarm Table	IV-5*	30202	R	Integer	
Device_Enable_DO_Word	Device Enable DO Word - See Table	IV-6	30206	R	Bit Pack	
Ref_Ckt_PressTemp_Alarm_Word	Refrigeration Circuit Word - See Table	IV-7	30210	R	Bit Pack	
Device_Offline_Word	Device Offline Word - See Table	IV-8	30214	R	Bit Pack	
Device_Alarm_Word	Device Alarm Word - See Table	IV-9	30218	R	Bit Pack	
System_Word	System Word - See Table	IV-10*	30222	R	Bit Pack	
Unit_Status_Word	Unit Status Word - See Table	IV-11*	30226	R	Bit Pack	
Exhaust_Fan_1_Status_Digital_Input	Exhaust Fan Status	BI-1*	10009	R	Active	Inactive
Supply_Fan_1_Status_Digital_Input	Supply Fan Status	BI-2*	10010	R	Active	Inactive
BMS_Watchdog	BMS Watchdog command Used to determine BMS comm status	BV-1*	2	RW	Active	Inactive
System_Enable	Master system enable/disable point	BV-2*	3	RW	Enable	Disable
BMS_Occupancy_Command	Occupancy Command	BV-3*	4	RW	Unoccupied	Occupied
Reset_All_Alarms	Alarm Reset Command	BV-4*	5	RW	Reset	Normal
Exhaust_Only_Mode_BMS_Cmd	Exhaust Mode Command	BV-5	6	RW	Enable	Disable
Pressurization_Only_Mode_BMS_Cmd	Pressurization Mode Command	BV-6	7	RW	Enable	Disable
Outside_RH_Source_BMS	Outside RH Source Selection	BV-7	8	RW	BMS	Local
Outside_Temp_Source_BMS	Outside Temp Source Selection	BV-8	9	RW	BMS	Local
Return_RH_Source_BMS	Return RH Source Selection	BV-9	10	RW	BMS	Local
Return_Temp_Source_BMS	Return Temp Source Selection	BV-10	11	RW	BMS	Local

## Appendix E: Points List

Variable	Description	BACnet	Modbus	Read Write	Text or Unit of M	
		Object	Register		Active	Inactive
Space_1_CO2_Source_BMS	Space 1 CO2 Source Selection	BV-11	12	RW	BMS	Local
Space_2_CO2_Source_BMS	Space 2 CO2 Source Selection	BV-12	13	RW	BMS	Local
Return_CO2_Source_BMS	Return CO2 Source Selection	BV-13	14	RW	BMS	Local
Space_RH_Source_BMS	Space RH Source Selection	BV-14	15	RW	BMS	Local
Space_Static_Source_BMS	Space Static Source Selection	BV-15	16	RW	BMS	Local
Space_Temp_Source_BMS	Space Temp Source Selection	BV-16	17	RW	BMS	Local
SF_Control_Source_BMS	Allows the BMS to control supply fan speed	BV-17	18	RW	BMS	Local
EF_Control_Source_BMS	Allows the BMS to control exhaust fan speed	BV-18	19	RW	BMS	Local
OAD_Control_Source_BMS	Allows the BMS to control OAD position	BV-19	20	RW	BMS	Local
Aux_BMS_Digital_Output_1	BMS Commanded auxiliary digital output	BV-20*	21	RW	Active	Inactive
Aux_BMS_Digital_Output_2	BMS Commanded auxiliary digital output	BV-21	22	RW	Active	Inactive
Occupied	Occupancy	BV-22*	10002	R	Occupied	Unoccupied
Global_Alarm	General alarm point Default set to indicate any alarm is active	BV-23*	10003	R	Alarm	Normal
BMS_Watchdog_Active	Status of the BMS watchdog heartbeat	BV-24	10004	R	Active	Inactive
OAD_Feedback_Error_Not_Economizing.Active	Feedback indicates OAD is not opening during economizer	BV-25*	10005	R	Alarm	Normal
OAD_Feedback_Error_Economizing.Active	Feedback indicates OAD is open	BV-26*	10006	R	Alarm	Normal
OAD_Feedback_Error_OAD_Not_Modulating.Active	Feedback indicates the OAD is not modulating	BV-27*	10007	R	Alarm	Normal
OAD_Feedback_Error_Excess_OA.Active	Feedback indicates the OAD is not closing	BV-28*	10008	R	Alarm	Normal
Supply_Fan_1_Alarm.Active	Supply Fan Alarm Active	BV-29*	10012	R	Alarm	Normal
Exhaust_Fan_1_Alarm.Active	Exhaust Fan Alarm Active	BV-30*	10013	R	Alarm	Normal
Drain_Pan_Alarm.Active	Condensate Drain Pan Alarm Active	BV-31*	10014	R	Alarm	Normal
Fire_Safety_Shutdown_Alarm.Active	Fire Safety Shutdown Alarm Active	BV-32*	10015	R	Alarm	Normal
Refrigerant_Leak_Compressor_Alarm.Active	Refrigerant Leak Compressor Alarm Active	BV-33*	10016	R	Alarm	Normal
Refrigerant_Leak_Airstream_Alarm.Active	Refrigerant Leak Airstream Alarm Active	BV-34*	10017	R	Alarm	Normal

\*Indicated point included in BACnet Short List

## Appendix E: Points List

Device Enable DO Word Table (IV-6/AV-94 & AV-95)									
IV	IV Bit	AV	AV Bit	Bit Description	IV	IV Bit	AV	AV Bit	Bit Description
<b>6</b>	0	<b>94</b>	0	Compressor 1 Start	<b>6</b>	16	<b>95</b>	0	IG Furnace 1 Stage 1 Start
	1		1	Compressor 2 Start		17		1	IG Furnace 2 Stage 1 Start
	2		2	Compressor 3 Start		18		2	IG Furnace 3 Stage 1 Start
	3		3	Compressor 4 Start		19		3	IG Furnace 4 Stage 1 Start
	4		4			20		4	Supply Fan Start
	5		5			21		5	Exhaust Fan Start
	6		6			22		6	IG Furnace 1 Stage 2 Start
	7		7			23		7	IG Furnace 2 Stage 2 Start
	8		8	Condenser Fan Ramp 1 Stage 1 Start		24		8	IG Furnace 3 Stage 2 Start
	9		9	Condenser Fan Ramp 1 Stage 2 Start		25		9	IG Furnace 4 Stage 2 Start
	10		10	Condenser Fan Ramp 1 Stage 3 Start		26		10	
	11		11			27		11	
	12		12	Condenser Fan Ramp 2 Stage 1 Start		28		12	
	13		13	Condenser Fan Ramp 2 Stage 2 Start		29		13	
	14		14	Condenser Fan Ramp 2 Stage 3 Start		30		14	
15	15		31	15					

Ref Ckt PressTemp Alarm Word Table (IV-7/AV-96 & AV-97)									
IV	IV Bit	AV	AV Bit	Bit Description	IV	IV Bit	AV	AV Bit	Bit Description
<b>7</b>	0	<b>96</b>	0	Circuit A Discharge Pressure Sensor Alarm	<b>7</b>	16	<b>97</b>	0	Circuit A Liquid Line Pressure Sensor Alarm
	1		1	Circuit A Discharge Temp Sensor Alarm		17		1	Circuit A Liquid Line Temp Sensor Alarm
	2		2	Circuit A Suction Pressure Sensor Alarm		18		2	Circuit B Liquid Line Pressure Sensor Alarm
	3		3	Circuit A Suction Temp Sensor Alarm		19		3	Circuit B Liquid Line Temp Sensor Alarm
	4		4	Circuit B Discharge Pressure Sensor Alarm		20		4	
	5		5	Circuit B Discharge Temp Sensor Alarm		21		5	
	6		6	Circuit B Suction Pressure Sensor Alarm		22		6	
	7		7	Circuit B Suction Temp Sensor Alarm		23		7	
	8		8	Circuit A High Pressure Switch Alarm		24		8	
	9		9	Circuit A Low Refrigerant Pressure Alarm		25		9	
	10		10	Circuit B High Pressure Switch Alarm		26		10	
	11		11	Circuit B Low Refrigerant Pressure Alarm		27		11	
	12		12	Circuit A High Sat Discharge Temp Alarm		28		12	
	13		13	Circuit B High Sat Discharge Temp Alarm		29		13	
	14		14			30		14	
15	15		31	15					

## Appendix E: Points List

Device Offline Word Table (IV-8/AV-98 & AV-99)									
IV	IV Bit	AV	AV Bit	Bit Description	IV	IV Bit	AV	AV Bit	Bit Description
<b>8</b>	0	<b>98</b>	0	Space TStat 1 Offline	<b>8</b>	16	<b>99</b>	0	IG Furnace Controller 1 Offline
	1		1	Space TStat 2 Offline		17		1	IG Furnace Controller 2 Offline
	2		2	Space TStat 3 Offline		18		2	IG Furnace Controller 3 Offline
	3		3	Space TStat 4 Offline		19		3	IG Furnace Controller 4 Offline
	4		4	VFD Offline Supply Fan		20		4	
	5		5	VFD Offline Exhaust Fan		21		5	
	6		6			22		6	
	7		7			23		7	
	8		8	Expansion Board 1 Alarm		24		8	
	9		9	Expansion Board 2 Alarm		25		9	
	10		10	Expansion Board 3 Alarm		26		10	
	11		11	Expansion Board 4 Alarm		27		11	Primary Unit Offline Alarm
	12		12			28		12	Secondary Unit 1 Offline Alarm
	13		13			29		13	Secondary Unit 2 Offline Alarm
	14		14			30		14	Secondary Unit 3 Offline Alarm
	15		15			31		15	Secondary Unit 4 Offline Alarm

Device Alarm Word Table (IV-9/AV-100 & AV-101)									
IV	IV Bit	AV	AV Bit	Bit Description	IV	IV Bit	AV	AV Bit	Bit Description
<b>9</b>	0	<b>100</b>	0	Cold Coil Temperature Sensor Alarm	<b>9</b>	16	<b>101</b>	0	Space CO2 Sensor Alarm
	1		1			17		1	Space RH Sensor Alarm
	2		2	Mixed Temperature Sensor Alarm		18		2	Space Static Pressure Sensor Alarm
	3		3	Supply Duct Static Pressure Sensor Alarm		19		3	Space Temperature Sensor Alarm
	4		4	Supply Fan AFMS Alarm		20		4	IG Furnace Alarm
	5		5	Supply Air Temp Sensor Alarm		21		5	IG Furnace Alarm Beckett
	6		6	Exhaust Fan AFMS Alarm		22		6	First Inverter Alarm
	7		7	Exhaust Temperature Sensor Alarm		23		7	Danfoss Oil Level Alarm
	8		8	Outside Air Temp Sensor Alarm		24		8	EVD Valve Alarm
	9		9	Outside RH Sensor Alarm		25		9	
	10		10			26		10	SF VFD Alarm
	11		11	Greentrol OAD AFMS Alarm		27		11	EF VFD Alarm
	12		12	Return CO2 Sensor Alarm		28		12	
	13		13	Return Duct Static Pressure Sensor Alarm		29		13	
	14		14	Return Temperature Sensor Alarm		30		14	
	15		15	Return RH Sensor Alarm		31		15	

## Appendix E: Points List

System Word (IV-10/AV-102 & AV-103)									
IV	IV Bit	AV	AV Bit	Bit Description	IV	IV Bit	AV	AV Bit	Bit Description
<b>10</b>	0	<b>102</b>	0	Heat Wheel Enable	<b>10</b>	16	<b>103</b>	0	Shutdown Input Alarm
	1		1	Preheat Enable		17		1	Energy Recovery Wheel High Diff Pressure
	2		2	Reversing Valve (Cooling (0)/Heating(1))		18		2	Energy Recovery Wheel Rotation Alarm
	3		3			19		3	
	4		4	OA Damper End Switch Alarm		20		4	Heat Pump Heating Lock Out Alarm
	5		5	EA Damper End Switch Alarm		21		5	BMS Frequent Writes - Reduce Num of Writes
	6		6	Supply Temp Low Limit Alarm		22		6	BMS Offline Alarm
	7		7	Supply Temp High Limit Alarm		23		7	
	8		8	Supply High Duct Static Alarm		24		8	
	9		9	Supply Fan 1 Alarm		25		9	
	10		10	Exhaust Fan 1 Alarm		26		10	
	11		11	Drain Pan Alarm		27		11	
	12		12			28		12	Heat-Cool Only - Dehumidification Request Active
	13		13	Filter Alarm		29		13	Heat-Cool Only - Heating Request Active
	14		14	Space High Static Alarm		30		14	Heat-Cool Only - Coil Setpoint Alarm Active
15	15	Return Low Static Alarm	31	15	Heat-Cool Only - Supply Setpoint Alarm Active				

Unit Status Word Table (IV-11/AV-104 & AV-105)									
IV	IV Bit	AV	AV Bit	Bit Description	IV	IV Bit	AV	AV Bit	Bit Description
<b>11</b>	0	<b>104</b>	0	Off/Standby	<b>11</b>	16	<b>105</b>	0	Case Heat Active
	1		1	Occupied Start		17		1	Fans Only
	2		2	Unoccupied Start		18		2	Economizing
	3		3	Opening Dampers		19		3	Energy Recovery Active
	4		4	Dampers Open		20		4	Cooling
	5		5	Fan Start Delay		21		5	Heating
	6		6	Exhaust Fan On		22		6	Dehumidifying
	7		7	Supply Fan On		23		7	Hot Gas Reheat Active
	8		8	System On		24		8	Oil Recovery Active
	9		9	Soft Shutdown		25		9	Dehum w/Heat
	10		10	System Disabled		26		10	Energy Recovery Defrost Active
	11		11	Remote Off		27		11	Heat Pump Defrost Active
	12		12	System Shutdown Alarm		28		12	Morning Warm Up/Cool Down Active
	13		13	Supply Fan Only		29		13	Winter Ramp Active
	14		14	Exhaust Fan Only		30		14	
15	15	Purge Mode (Supply and Exhaust Only)	31	15	Overrides Active				

## Appendix E: Points List

Unit Status Mode Table (AV-40)			
0	Standby	20	Economizing
1	Unoccupied Start	21	Cooling
2	Occupied Start	22	Heating
3	Opening Dampers	23	Dehumidifying
5	Dampers Open	24	
6	Fan Start Delay	25	HGRH Purging
7	Exhaust Fan Start	26	Energy Recovery Defrost Active
8	Supply Fan Start	27	A2L Refrigerant Leak Alarm
9	Startup Delay	28	A2L Refrigerant Leak Alarm Fan Only Mode
10	System On	29	Dehumidifying w/Heat
11	Soft Shutdown	30	Overrides
12	System Disabled	31	Expansion Offline
13	Remote Off (S1 Open)	32	
14	System Shutdown Alarm	33	Energy Recovery Active
15	Supply Fan Only	34	Hot Gas Reheat Active
16	Exhaust Only	35	Morning Sequence Active
17	Fans Only Purge	36	Heat Pump Defrost
18	Case Heat Active	37	Winter Ramp Active
19	Fans Only		

LatestAlm (Alarm) Table (BACnet IV-5/AV-93)			
0	No Active Alarms -	32	BMS Frequent Writes - Reduce Num of Writes
1	Supply Fan 1 Run - Status Not Proven	33	Space 1 CO2 - Sensor Value Not Valid
3	High Supply Duct - Static Pressure	34	Space Static Pressure - Sensor Value Not Valid
4	Low Return Duct - Static Pressure	35	Supply Duct Stat Press - Sensor Value Not Valid
5	Outside Air Temp - Sensor Value Not Valid	36	Return Duct Stat Press - Sensor Value Not Valid
6	Supply Air Temperature - Sensor Value Not Valid	37	Sup Fan 1 AFMS - Sensor Value Not Valid
7	Cold Coil 1 Temp - Sensor Value Not Valid	38	Exh Fan 1 AFMS - Sensor Value Not Valid
9	Exhaust Air Temp - Sensor Value Not Valid	41	Space 2 CO2 - Sensor Value Not Valid
10	Mixed Air Temperature - Sensor Value Not Valid	42	Return CO2 - Sensor Value Not Valid
11	Return Air Temperature - Sensor Value Not Valid	43	Discharge Press Ckt A - Sensor Value Not Valid
12	Space Temperature - Sensor Value Not Valid	44	Discharge Press Ckt B - Sensor Value Not Valid
13	Return Air RH - Sensor Value Not Valid	47	Suction Press Ckt A - Sensor Value Not Valid
14	Space RH - Sensor Value Not Valid	48	Suction Press Ckt B - Sensor Value Not Valid
15	Outside RH - Sensor Value Not Valid	51	Discharge Temp Ckt A - Sensor Value Not Valid
16	Low Refrig Pressure - Circuit A	52	Discharge Temp Ckt B - Sensor Value Not Valid
17	Low Refrig Pressure - Circuit B	55	Suction Temp Ckt A - Sensor Value Not Valid
20	High Pressure Switch - Circuit A	56	Suction Temp Ckt B - Sensor Value Not Valid
21	High Pressure Switch - Circuit B	59	Ckt A High Saturated - Discharge Temperature
24	Damper End Switch Fail - Dampers are not open	60	Ckt B High Saturated - Discharge Temperature
25	Exhaust Fan 1 Run - Status Not Proven	63	Supply Air Temperature - Low Limit Shutdown
26	Filters are Dirty - Replace Filters	64	Heat Wheel Rotation - Not Detected
27	Cond Drain Pan Full - Check Drain	65	Secondary Unit Offline - Unit 1
28	Exp Board 1 Status - Board is Offline	66	Secondary Unit Offline - Unit 2
29	Exp Board 2 Status - Board is Offline	67	Secondary Unit Offline - Unit 3
30	Exp Board 3 Status - Board is Offline	68	Secondary Unit Offline - Unit 4
31	Exp Board 4 Status - Board is Offline	69	Primary Unit Offline

## Appendix E: Points List

LatestAlm (Alarm) Table (BACnet IV-5/AV-93) (cont.)			
71	Multi Devices per Ch - Contact Tech Support	127	First Inverter Lockout - Cycle Power to Unit
75	Comp Maint Alarm - Run Hours Spt Reached	133	Space Thermostat 1 - Sensor Offline
76	Supply Air Temperature - High Limit Shutdown	134	Space Thermostat 2 - Sensor Offline
77	Space High Static Pres - Shutdown	135	Space Thermostat 3 - Sensor Offline
78	Internal Board Temp - Exceeds -40F or 158F	136	Space Thermostat 4 - Sensor Offline
79	BMS Offline - Watchdog is FALSE	137	IG Furnace 1 - No flame after 3 tries
80	Clg Coil Setpt Input - Value is not valid	138	IG Furnace 1 - Large - No flame after 3 tries
81	Sup Air Setpt Input - Value is not valid	139	IG Furnace 1 Combust - Fan High Pressure Sw
82	BACnet License - Not Installed	140	IG Furnace 1 Ignition - Controller Alarm
83	Low Suction SH ExV A - EVD 1 Alarm	141	IG Furnace 1 Pressure - Switch Fault Alarm
84	Low Suction SH ExV B - EVD 1 Alarm	142	IG Furnace 1 Combust - Fan Proving Alarm
85	LOP A EVD 1 - Low Operating Pressure	143	IG Furnace 1 - Max Retries
87	MOP A EVD 1 - Max Operating Pressure	144	IG Furnace 1 - High Limit Trip
89	EEV A EVD 1 - Motor Alarm	145	IG Furnace - pCOe 1 Offline
91	LowSuct A EVD 1 - Refrigerant Temp	146	IG Furnace 1 IC Fault - Check Furnace Wiring
93	High Condensing Temp - EVD 1	147	IG Furnace 2 - No flame after 3 tries
94	Sens S1 EVD 1 - Sensor Value Not Valid	148	IG Furnace 2 - Large - No flame after 3 tries
95	Sens S2 EVD 1 - Sensor Value Not Valid	149	IG Furnace 2 Combust - Fan High Pressure Sw
96	Sens S3 EVD 1 - Sensor Value Not Valid	150	IG Furnace 2 Ignition - Controller Alarm
97	Sens S4 EVD 1 - Sensor Value Not Valid	151	IG Furnace 2 Pressure - Switch Fault Alarm
98	EVD 1 EEPROM Damaged - Call Tech Support	152	IG Furnace 2 Combust - Fan Proving Alarm
99	Incomplete Closing - EVD 1	153	IG Furnace 2 - Max Retries
100	Emergency Closing - EVD 1	154	IG Furnace 2 - High Limit Trip
101	EVD 1 Battery -	155	IG Furnace - pCOe 2 Offline
102	FW Incompatibility - EVD 1	156	IG Furnace 2 IC fault - Check Furnace Wiring
103	EVD 1 Config Error -	157	Outside Air Greentrol - Offline or Flow Error
104	EVD 1 Comm - EVD 1 is Offline	169	ER Wheel High - Differential Pressure
105	High Discharge Temp - First Inv Envelope	170	OA Damper Fault - Not Econ and should be
106	Low Discharge Pressure - First Inv Envelope	171	OA Damper Fault - Econ and shouldn't be
107	High Suction Pressure - First Inv Envelope	172	OAD Fault - Damper not Modulating
108	Low Suction Pressure - First Inv Envelope	173	OAD Fault - Excess Outdoor Air
109	High Current - First Inv Envelope	174	IG Furnace 1 - Combustion Fan Alarm
110	High Pressure Ratio - First Inv Envelope	175	IG Furnace 2 - Combustion Fan Alarm
111	Low Pressure Ratio - First Inv Envelope	176	Supply Fan - VFD Offline
112	Low Delta P - First Inv Envelope	177	Exhasut Fan - VFD Offline
113	High Discharge Press - First Inv Envelope	180	Embedded EVD Error -
114	Compressor Staging - Order Skipped	181	SF VFD Alarm - Check VFD
115	Heat Pump Heating - Locked Out	182	EF VFD Alarm - Check VFD
116	EVD 1 Error - Unexpected Position	185	First Inverter - Low Oil Detected
117	High SDT Lockout - Circuit A	186	Compressor Refrig Leak - Furnace Locked Out
118	High SDT Lockout - Circuit B	187	Airstream Refrig Leak - SF Mitigation Sequence
121	First Inverter Alarm - Resettable	188	Fire Shutdown Alarm - Building Fire Alarm
122	First Inverter Alarm - Serious	189	EA Damper End Switch - Damper is not open
123	First Inverter Alarm - Irreversible	190	Liquid Line Temp Ckt A - Sensor Value Not Valid
124	First Inverter PEC - Invalid Data Set	191	Liquid Line Temp Ckt B - Sensor Value Not Valid
125	First Inverter STO - Safe Torque Off Open	192	Liquid Line Pres Ckt A - Sensor Value Not Valid
126	First Inverter Offline - Modbus Comms Lost	193	Liquid Line Pres Ckt B - Sensor Value Not Valid

## Appendix E: Points List

LatestAlm (Alarm) Table (BACnet IV-5/AV-93) (cont.)

194	IG Furnace Board 3 Offline	202	IG Furnace 4 Pressure Switch Fault Alarm
195	IG Furnace Board 4 Offline	203	IG Furnace 4 Combust Fan Proving Alarm
196	IG Furnace 3 Combust Fan High Pressure Sw	204	IG Furnace 4 Max Retries
197	IG Furnace 3 Pressure Switch Fault Alarm	205	IG Furnace 4 High Limit Trip
198	IG Furnace 3 Combust Fan Proving Alarm	206	IG Furnace 1 Lockout See Furnace Alarm Code
199	IG Furnace 3 Max Retries	207	IG Furnace 2 Lockout See Furnace Alarm Code
200	IG Furnace 3 High Limit Trip	208	IG Furnace 3 Lockout See Furnace Alarm Code
201	IG Furnace 4 Combust Fan High Pressure Sw	209	IG Furnace 4 Lockout See Furnace Alarm Code

## Appendix F: Factory Modbus Connections

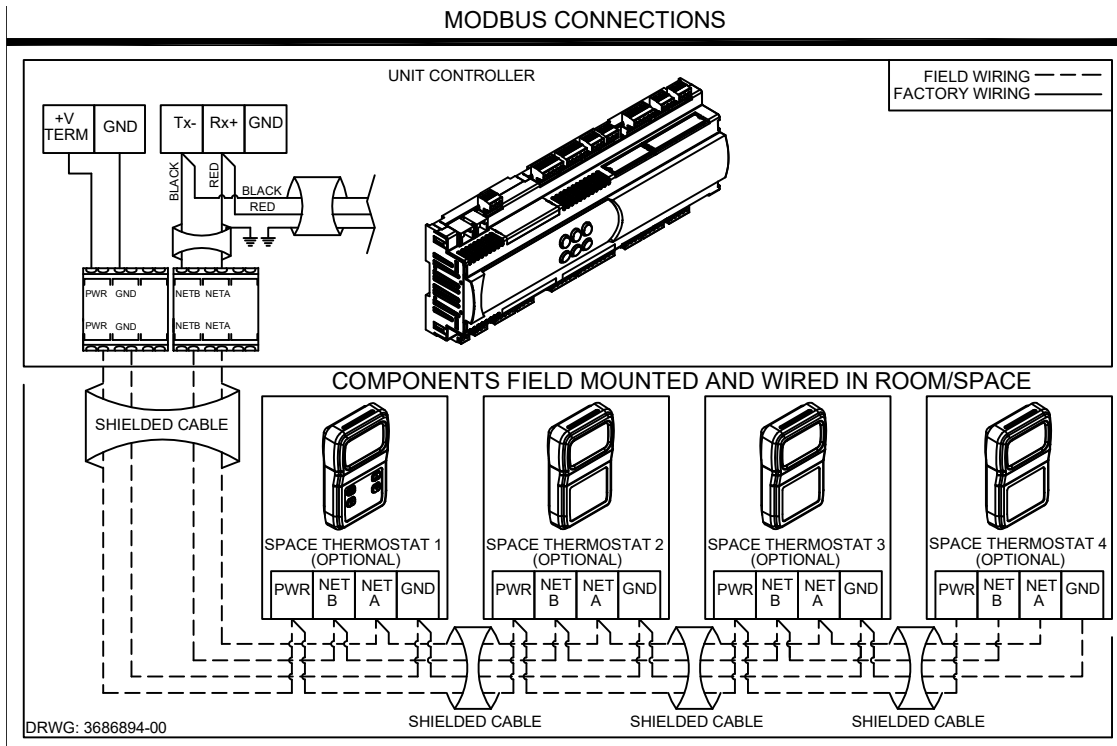

## Appendix G: NTC Temperature Sensor Chart

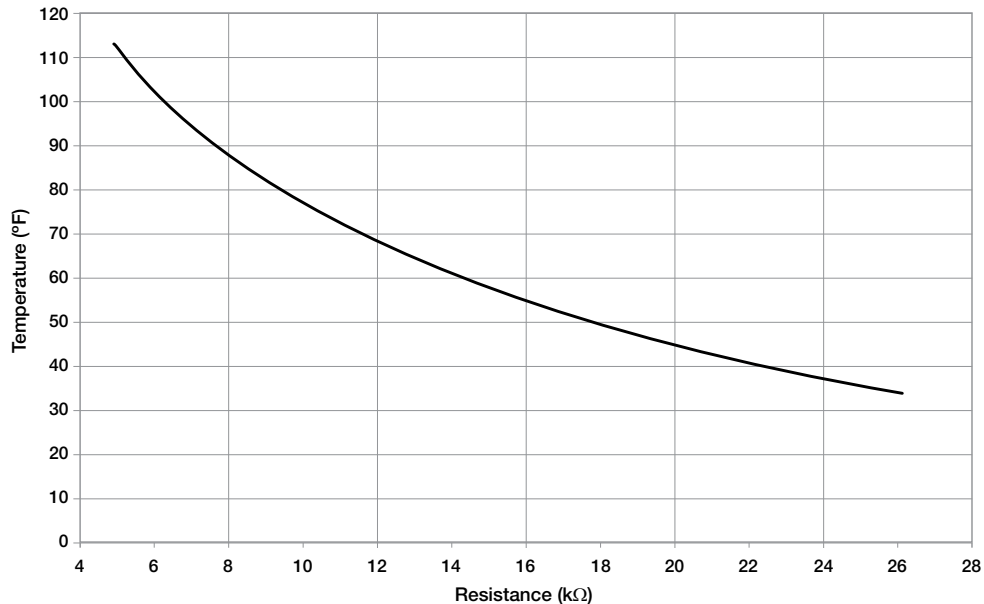

## Appendix H: Fault Detection and Diagnostics

The Fault Detection and Diagnostics (FDD) will send a feedback signal from the outdoor air (OA) damper to the controller on the user interface. This allows the controller to determine if the economizer is operating correctly. Various faults and statuses display on the controller and through the Building Management System as per the Title 24 Economizer Fault Detection and Diagnostic requirements.

### Enable Fault Detection and Diagnostics

When ordered, the FDD will come enabled from the factory. The FDD alarms can be disabled through the service config menu in the controller. To access the service config menu, navigate the following way: Ctrl Variables/Advanced/Unit Config/Service Config. Alarm tolerance and read frequency will also be able to be adjusted through this menu.

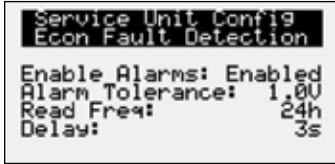

There will be an 'Actuator Feedback' screen in the 'Service Info' menu that will show the commanded damper position, the actual feedback position, and when the damper positions were last read. This screen is also where the field could force the FDD to read the damper position via a check box option. The service info menu can be accessed via the following: Ctrl Variables/Advanced/Service Info

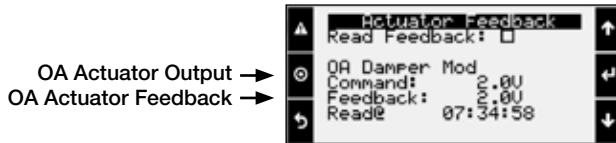

**Faults/Alarms** - Additional faults can generate when the Economizer FDD is enabled, below is a list of the alarms and a description of each. These alarms can also be generated through a BACnet® protocol only.

- **Not Economizing when it should** will generate when FDD is enabled, the outdoor damper status is active on economizer, and the feedback signal from the OA damper is below the damper commanded

position by more than 1VDC. Because of the speed of the actuator there is a 3-minute alarm delay to allow the actuator a chance to “catch up” if a sudden change in damper position happens.



- **Economizing when it should not** will generate when FDD is enabled, the outdoor damper status is NOT active on economizer, and the feedback signal from the OA damper is above the damper commanded position by more than 1VDC. Because of the speed of the actuator there is a 3-minute alarm delay to allow the actuator a chance to “catch up” if a sudden change in damper position happens.



- **Damper not modulating** will show up when FDD is enabled, Damper status is NOT Active on Economizer, and feedback signal is not within 1VDC above or below the damper commanded position within 180 seconds.

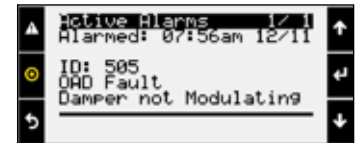

- **Excess outdoor air** will generate when FDD is enabled, the outdoor damper status is active on economizer, and the feedback signal from the OA damper is above the damper commanded position by more than 1VDC. Because of the speed of the actuator there is a 3-minute alarm delay to allow the actuator a chance to “catch up” if a sudden change in damper position happens.



Below are the BMS Points available if Fault Detection and Diagnostic Alarms are selected:

Variable	Description	BACnet	Modbus	Read or Write	Text or Unit of M	
		Object	Register		Active	Inactive
OAD_Feedback_Error_Not_Economizing.Active	Feedback indicated OAD is not opening during economizer	BV-25*	10005	R	Alarm	Normal
OAD_Feedback_Error_Economizing.Active	Feedback indicated OAD is open	BV-26*	10006	R	Alarm	Normal
OAD_Feedback_Error_OAD_Not_Modulating.Active	Feedback indicated the OAD is not modulating	BV-27*	10007	R	Alarm	Normal
OAD_Feedback_Error_Excess_OA.Active	Feedback indicates the OAD is not closing	BV-28*	10008	R	Alarm	Normal

## Appendix I: Refrigerant Leak Detection System

Units using R454B refrigerant are equipped with up to two sensors in the evaporator coil and supply fan sections that can trigger a Refrigerant Leak Airstream alarm. Units with an indirect gas furnace near the compressor will have an additional sensor in the compressor section that can trigger a Refrigerant Leak Compressor alarm. Units with other heating options, such as electric heat or hot water, will not have this additional sensor. The A2L sensors are normally-closed contacts with a 5min reset delay, and an LED indicator on the back. When a leak is detected, the sensor contacts open which triggers electro-mechanical overrides, and a controller sequence mandated by UL60335-2-40.

If the controller receives a Fire Safety Shutdown Alarm signal, it will disable the unit and ignore electro-mechanical overrides for leak detection.

### Refrigerant Leak Detected in Airstream Tunnel:

Refrigerant Leak Airstream Alarm signal is sent to the unit controller and terminals for the building to use. The following steps occur when this alarm is active:

- Unit is enabled.
- Occupancy status is changed to 'Occupied.'
- Compressors are disabled.
- Damper actuator positions are adjusted.
  - If the unit is 100% outside air, outside air dampers are fully opened.
  - If the unit has partial recirculation, recirculation dampers are fully opened.
- Supply fan speed is adjusted to the minimum required supply air flow.
- Controller delays and system shutdown alarms are ignored.

An alarm notification will be sent to the building management system (BMS). When the alarm clears, devices and unit controller will return to normal operations. This sequence is required to reduce the leakage rate and safely dilute stagnant refrigerant in the unit.

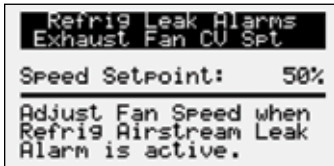

This variable allows the user to adjust the exhaust fan speed setpoint when a Refrigerant Airstream Alarm is active. This setting can be found in the General Alarm menu.

### Refrigerant Leak Detected in Compressor Compartment:

Refrigerant Leak Compressor Alarm signal is sent to the unit controller and terminals for the building to use. The following steps occur when this alarm is active:

- Compressors are disabled.
- Indirect gas furnace is disabled.

The unit is allowed to operate without tempering, based on a variable specified by the user. An alarm notification will be sent to the building management system (BMS). When the alarm clears, devices and unit controller will return to normal operations. This sequence is required to reduce leakage rate and eliminate ignition sources.

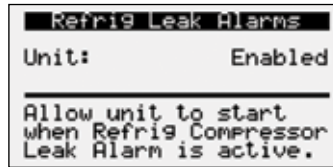

This variable allows the unit to continue running when a Refrigerant Compressor Alarm is active. If this set to 'disabled,' the controller will disable the unit when in alarm. This setting can be found in the General Alarm menu.

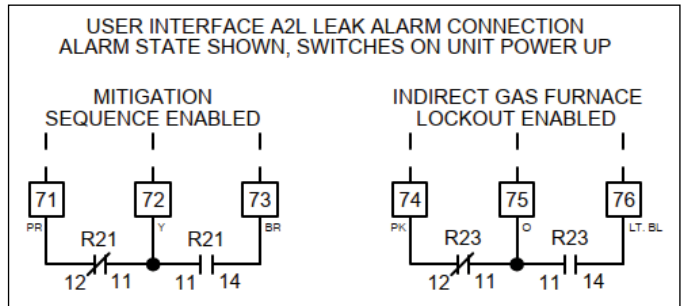

The terminals for Refrigerant Airstream and Compressor alarms are provided as normally open or normally closed contacts for the building to use.

Below are the BMS Points available for Refrigerant Leak Detection:

Variable	Description	BACnet	Modbus	Read or Write	Text or Unit of M	
		Object	Register		Active	Inactive
Fire_Safety_Shutdown_Alarm.Active	Fire Safety Shutdown Alarm Active	BV-32*	10014	R	Alarm	Normal
Refrigerant_Leak_Compressor_Alarm.Active	Refrigerant Leak Compressor Alarm Active	BV-33*	10015	R	Alarm	Normal
Refrigerant_Leak_Airstream_Alarm.Active	Refrigerant Leak Airstream Alarm Active	BV-34*	10016	R	Alarm	Normal

## Contact Us

### Technical Support and Service

800-789-8550

[support@doas.com](mailto:support@doas.com)

### Valent Dedicated Outdoor Air Systems

60–28th Avenue North

Minneapolis, MN 55411

Main: 612-877-4800

## More Information

### Unit Schematics

For configuration and connection questions, see the schematics that shipped with your unit. They can typically be found attached to the main control panel door.

### Mechanical and Controls Manuals

Find current mechanical and controls manuals here: [www.valentair.com/resources](http://www.valentair.com/resources)



**OUTDOOR AIR EXPERTS**  
**ROBUST DESIGNS**  
**DEDICATED SUPPORT**

[valentair.com](http://valentair.com)